



PRAYAS

JEE 2025

ATDB.uno

Lecture – 04

Physics

Ray optics



By- Saleem Ahmed Sir



Topics *to be covered*

1 # *Mirror formula & application*

ATDB.uno

2 # *Velocity of image*

3 #

4 #

Q

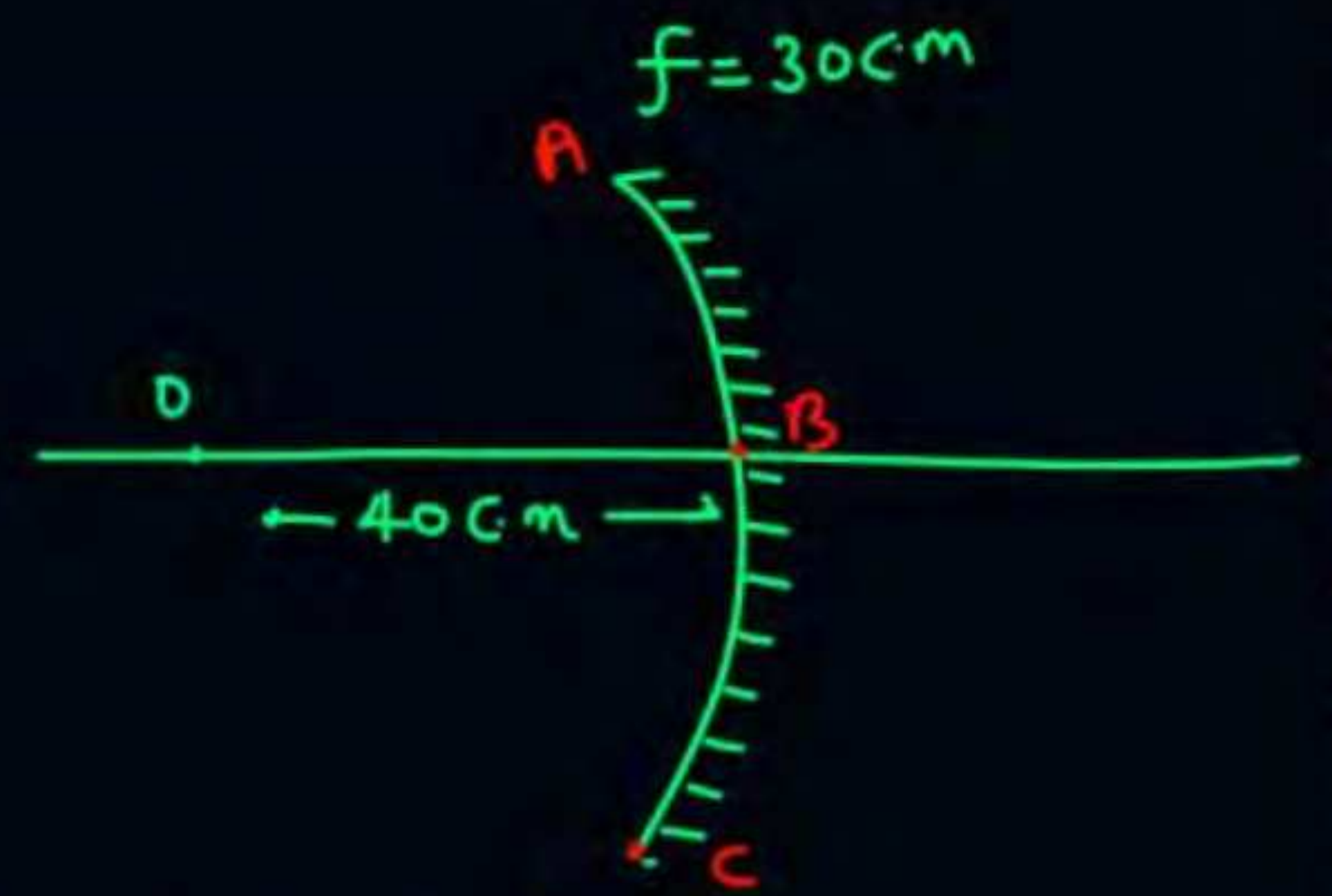

Mirror is cut at B
 & upper part is shifted up by 2mm
 & lower part is shifted down by 3mm
 find gap b/w two image

Solⁿ

$$u = \frac{1200}{-40 - (-30)} = -120$$

$$m = - \frac{-120}{-40} = -3$$

ATDB.uno

Solⁿ

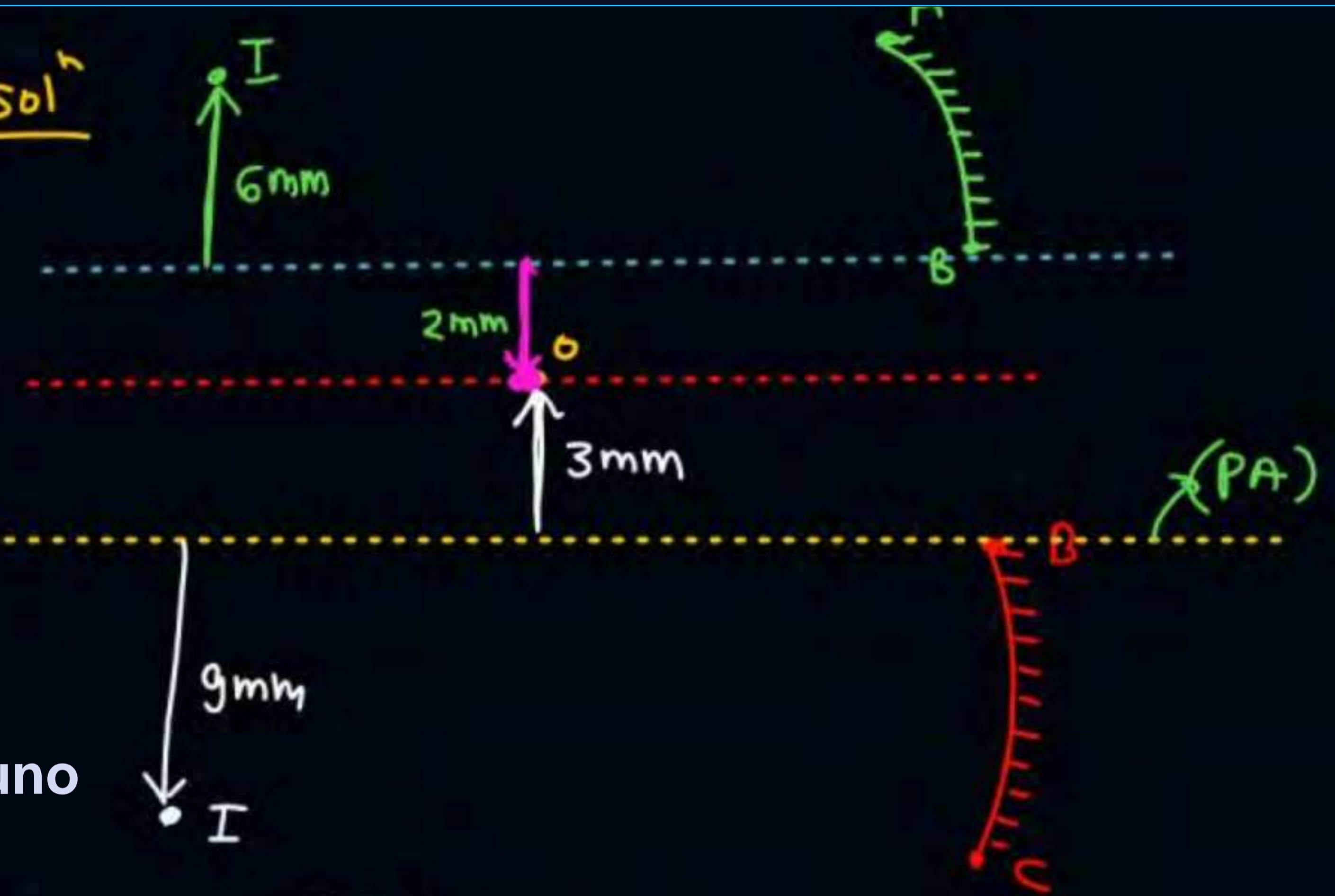

Ans \equiv **20 mm**

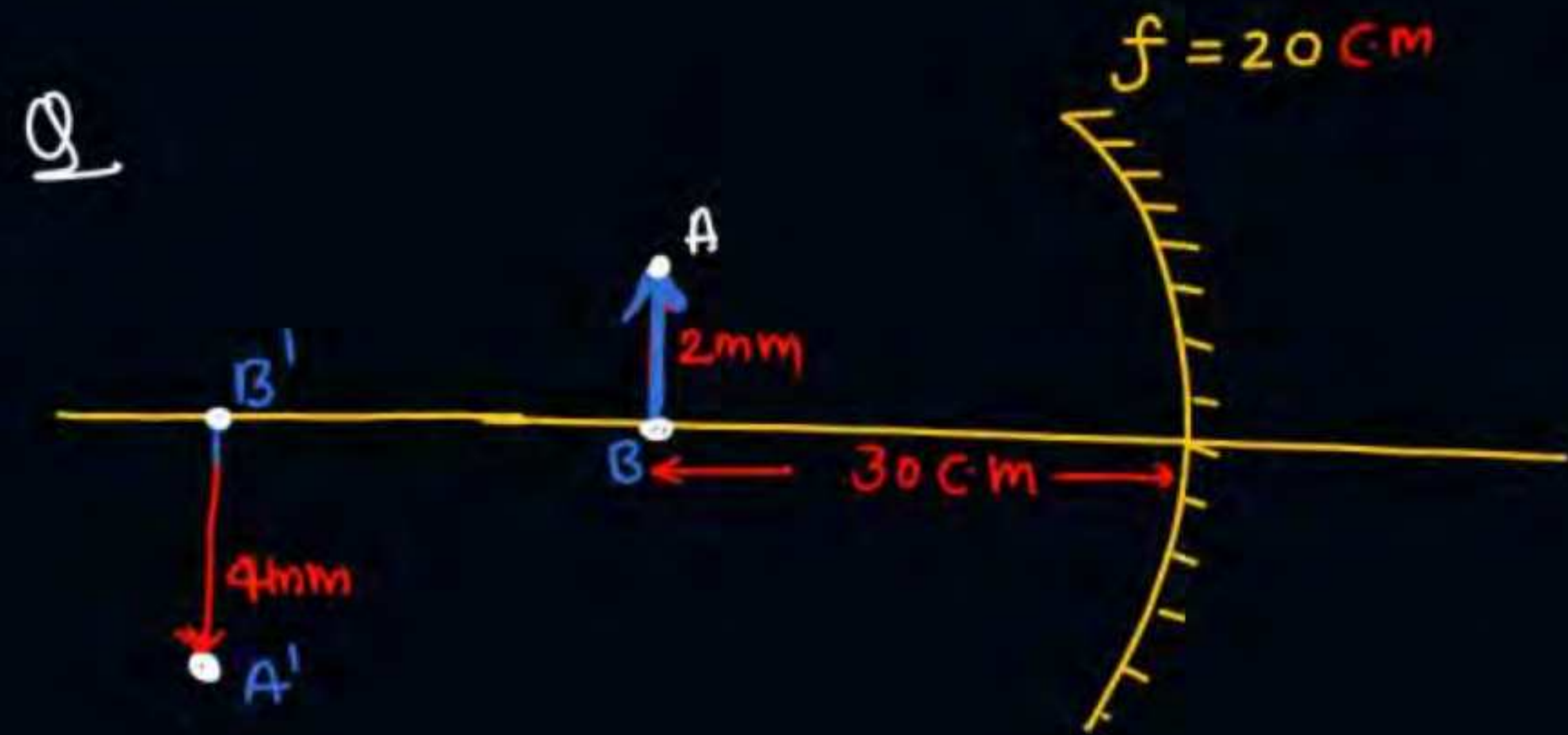

If $AB \equiv$ extended object f length $\equiv 2 \text{ mm}$
 $A'B' \equiv$ " image " " $= 4 \text{ mm}$

Q

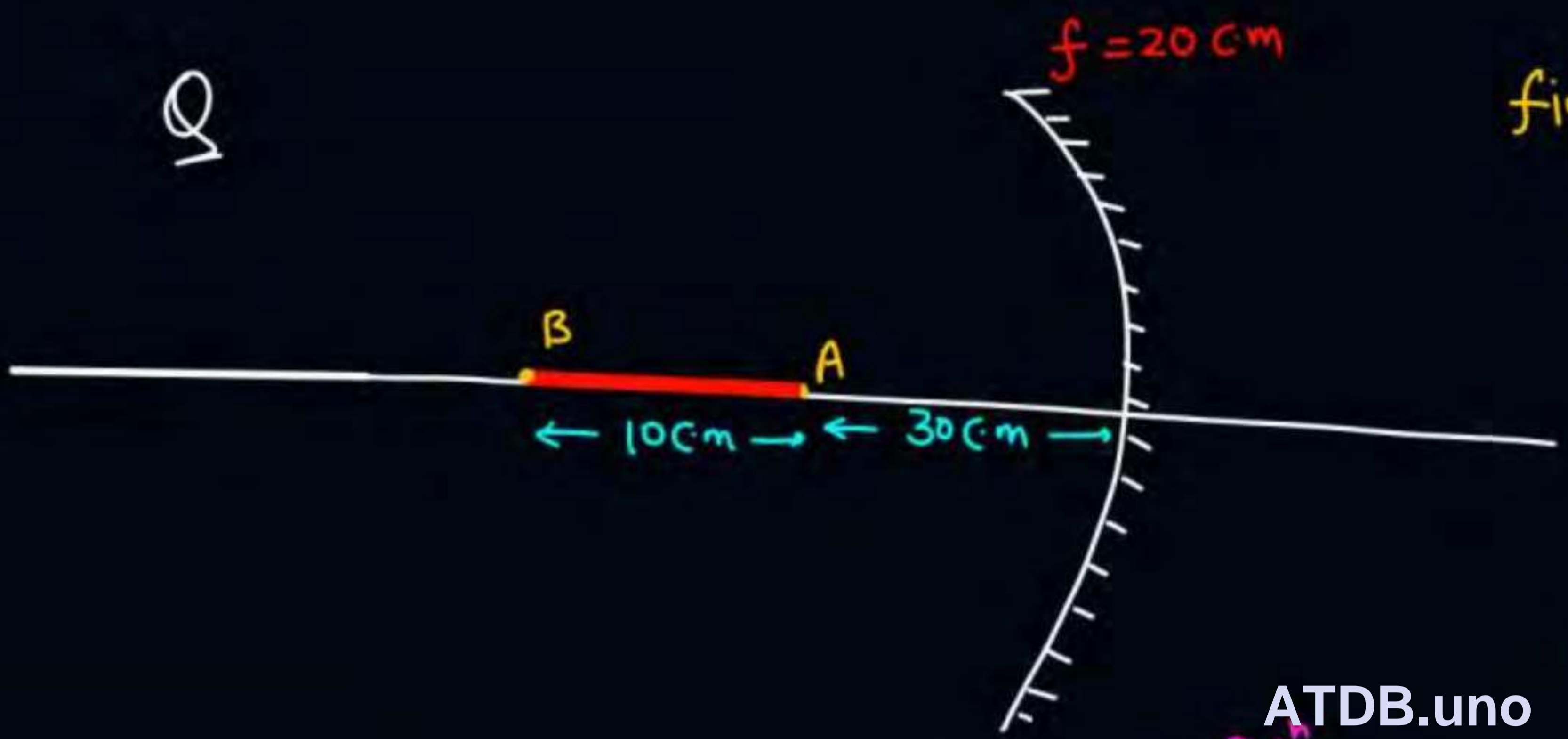

find Length of the image. \equiv ?

Solⁿ for A' $\left. \begin{matrix} u = -30 \\ f = -20 \end{matrix} \right\} v = -60$

|||
A'

for B' $\left(\begin{matrix} u = -40 \\ f = -20 \end{matrix} \right) \Rightarrow v = -40$

ATDB.uno
Solⁿ

Length of image = $A'B' = 20 \text{ cm}$

Longitudinal magnification = $\frac{\text{Length of image}}{\text{Length of obj}} = \frac{A'B'}{AB}$

$= \frac{20}{10} = 2$

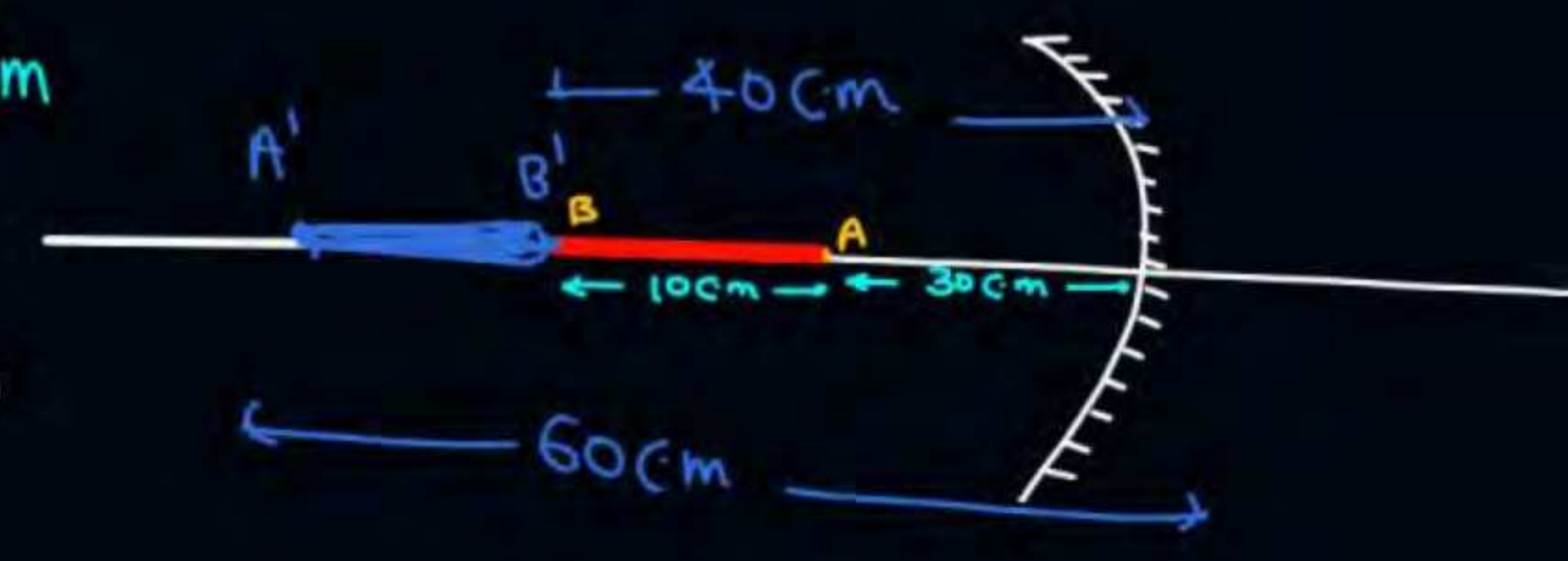

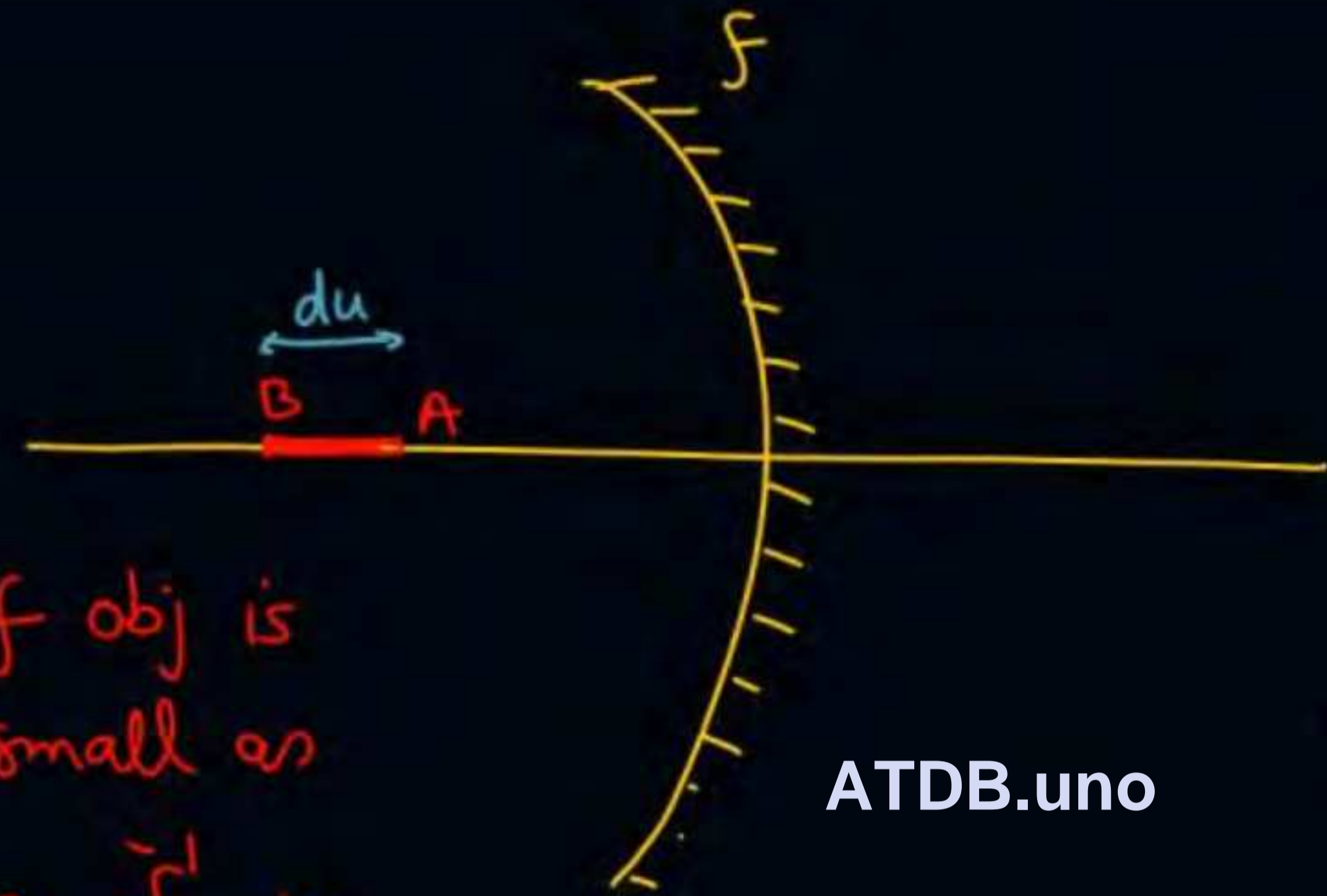

if length of obj is
very very small as
compare to f, u

$$m_t = m = -\frac{v}{u}$$

$$m^2 = \frac{v^2}{u^2}$$

ATDB.uno

$$\frac{1}{u} + \frac{1}{v} = \frac{1}{f}$$

$$-\frac{1}{u^2} du - \frac{1}{v^2} dv = 0$$

$$-\frac{1}{u^2} du = +\frac{1}{v^2} dv$$

$$dv = -\frac{v^2}{u^2} (du)$$

length of image = $-m^2$ (length of the obj)

$$A'B' = -m^2 (AB)$$

Q

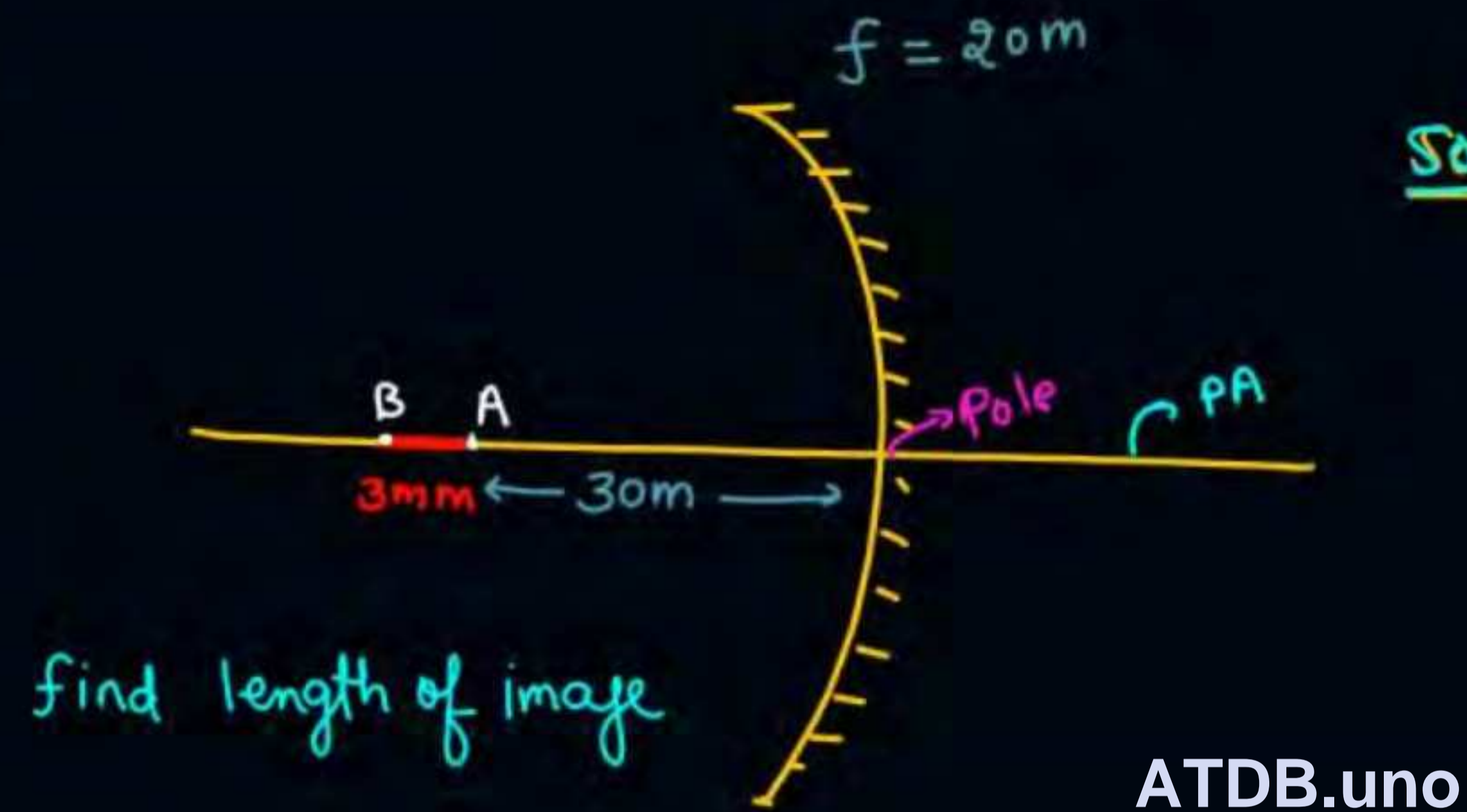
Solⁿ

$$m = -2$$

$$\begin{aligned} \text{length of image} &= m^2 \times AB \\ &= 4 \times 3\text{mm} = 12\text{mm} \\ &\quad (\text{magnitude}) \end{aligned}$$

ATDB.uno

Transverse magnification $m = \frac{h_i}{h_o} = \frac{-v}{u}$

Longitudinal magnification $m = \frac{\text{Length of image on PA}}{\text{" " " obj on PA}}$

ATDB.uno



$\frac{1}{u} + \frac{1}{v} = \frac{1}{f}$
 differentiate wrt t

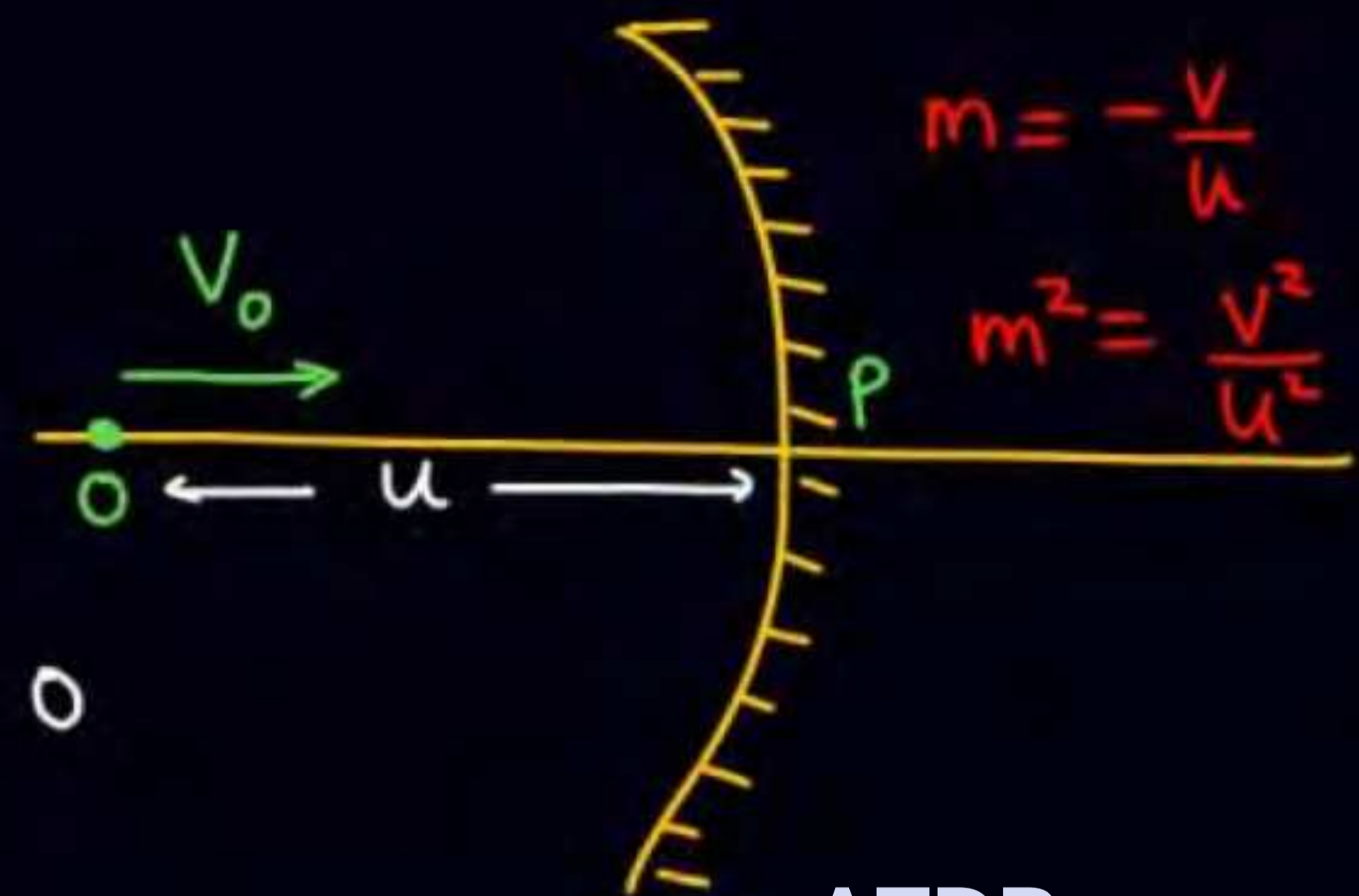

$m = -\frac{v}{u}$
 $m^2 = \frac{v^2}{u^2}$

$\vec{V}_I = -m^2 \vec{V}_O$ (Along P.A)
 (wrt mirror)

$\vec{V}_{I/m} = -m^2 \vec{V}_{O/m}$

$-\frac{1}{u^2} \frac{du}{dt} + \left(-\frac{1}{v^2} \frac{dv}{dt}\right) = 0$

$-\frac{1}{v^2} \frac{dv}{dt} = \frac{1}{u^2} \frac{du}{dt}$

$\frac{dv}{dt} = -\frac{v^2}{u^2} \frac{du}{dt}$

$V_I = -m^2 V_O$

ATDB.uno

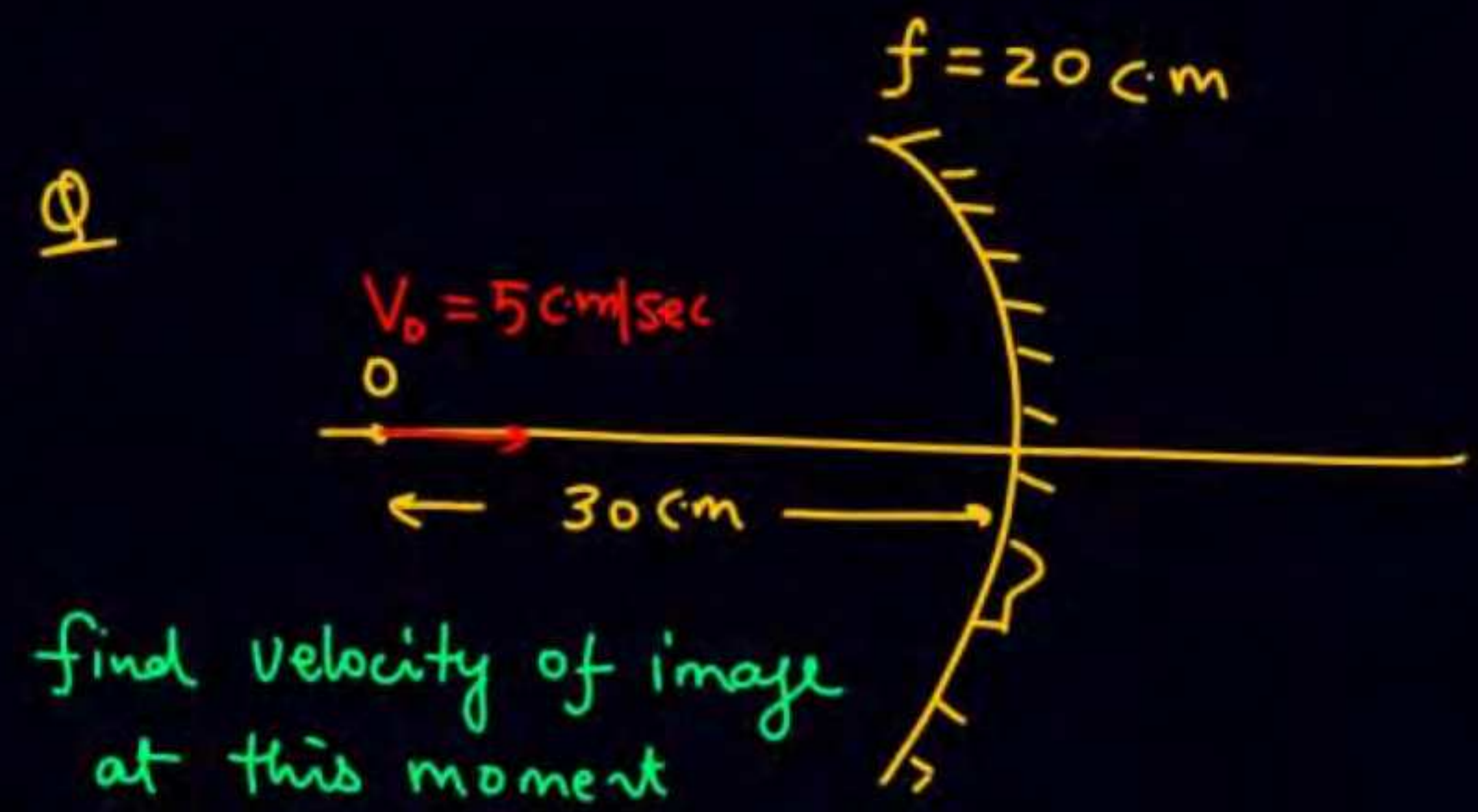

Solⁿ

$$\left. \begin{matrix} u = -30 \\ f = -20 \end{matrix} \right\} v = \frac{600}{-30 + 20} = -60$$

$$m = -\frac{v}{u} = -\frac{-60}{-30} = -2$$

$$\vec{V}_I = -m^2 \vec{V}_o \Rightarrow \vec{V}_I = -4 \times 5 \hat{i} = -20 \hat{i}$$

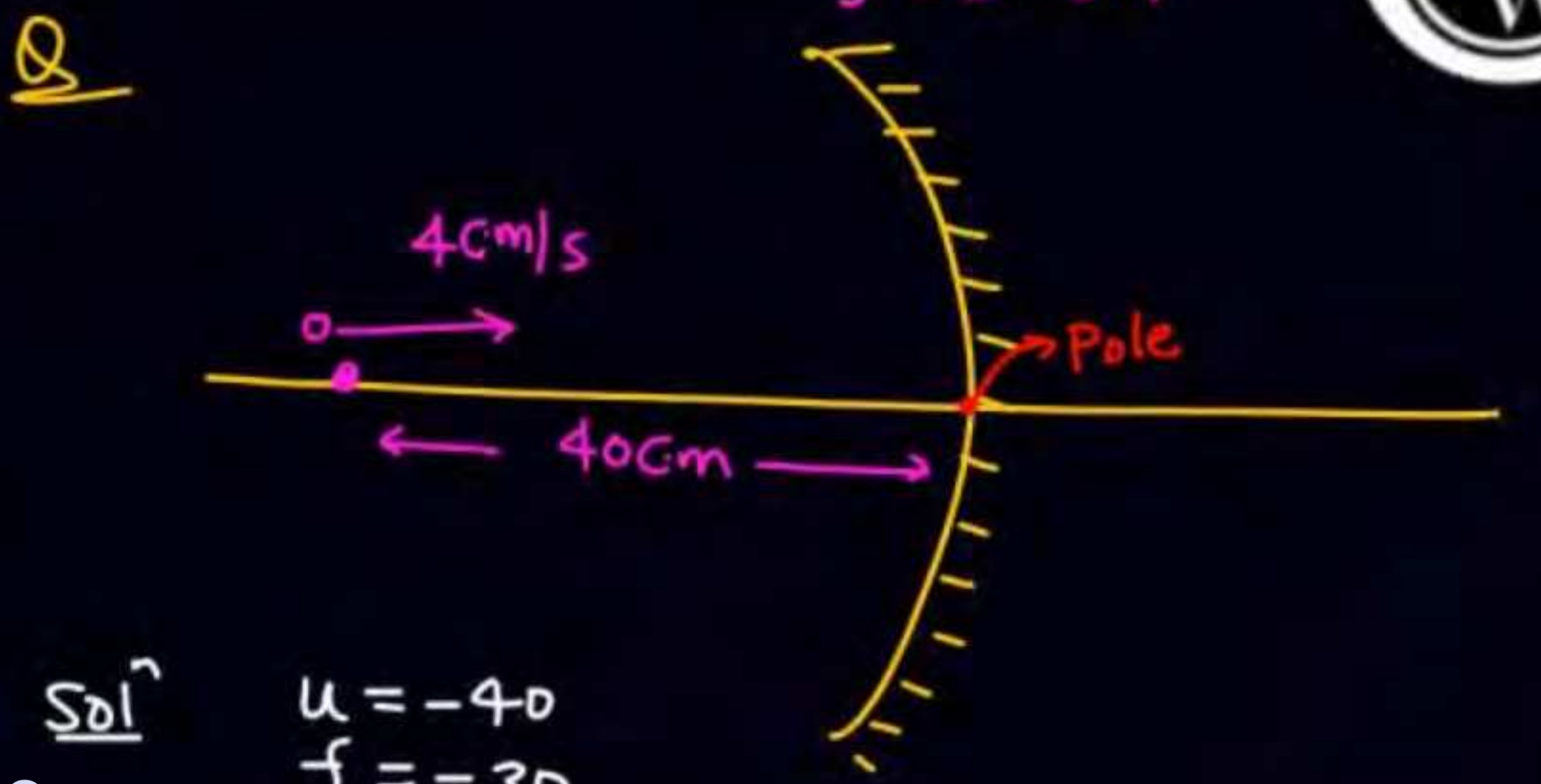

Solⁿ

$$\begin{matrix} u = -40 \\ f = -30 \\ \hline v = -120 \\ m = -\frac{v}{u} = -\frac{-120}{-40} = -3 \end{matrix}$$

$$V_I = -m^2 V_o$$

$$\vec{V}_I = -9 \times 4 \hat{i} = -36 \hat{i}$$

ATDB.uno

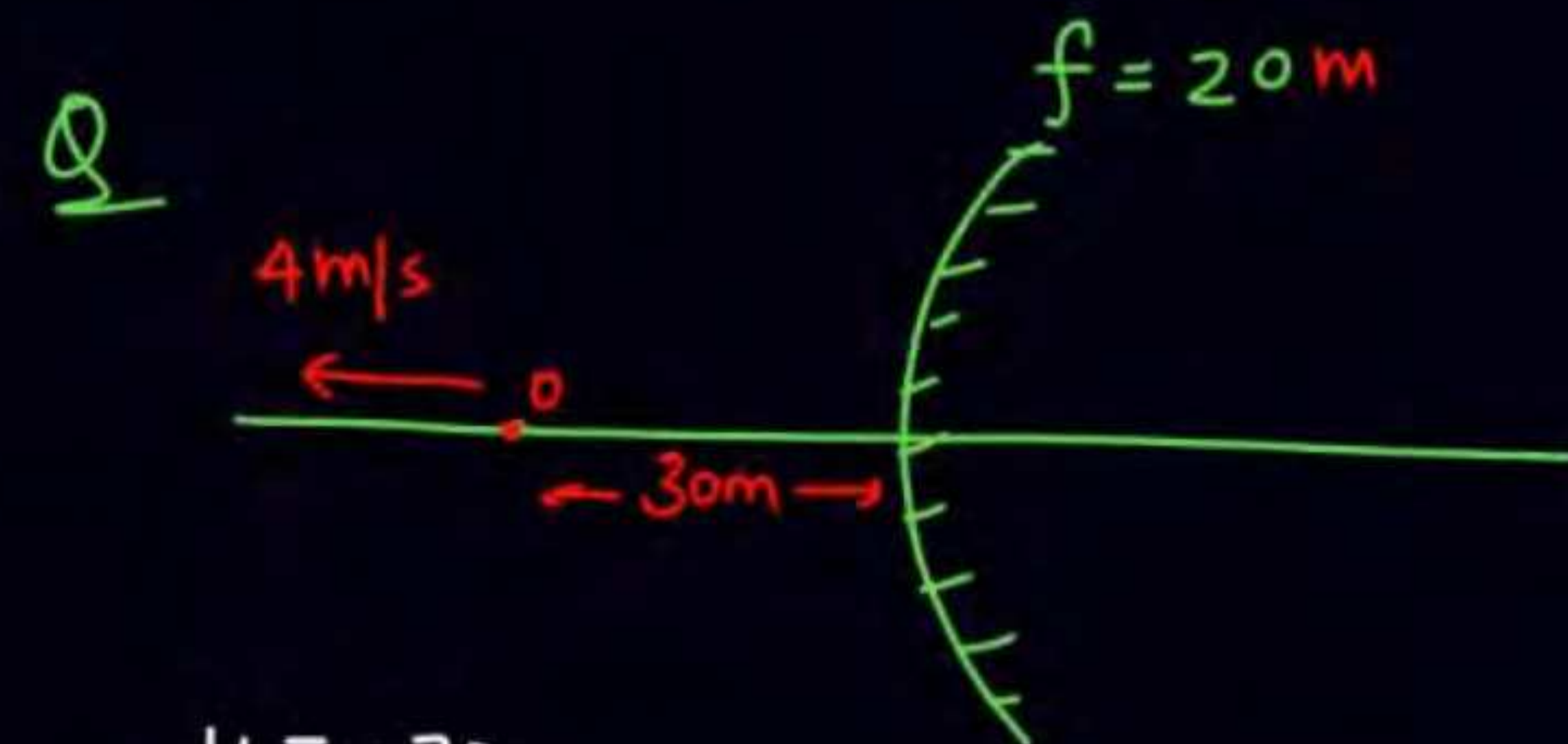

$$u = -30$$

$$f = +20$$

$$v = \frac{-600}{-30 - 20} = 12$$

$$m = -\frac{12}{-30} = \frac{2}{5}$$

$$V_I = -\left(\frac{2}{5}\right)^2 \times (-4\hat{i})$$

= ✓

ATDB.uno

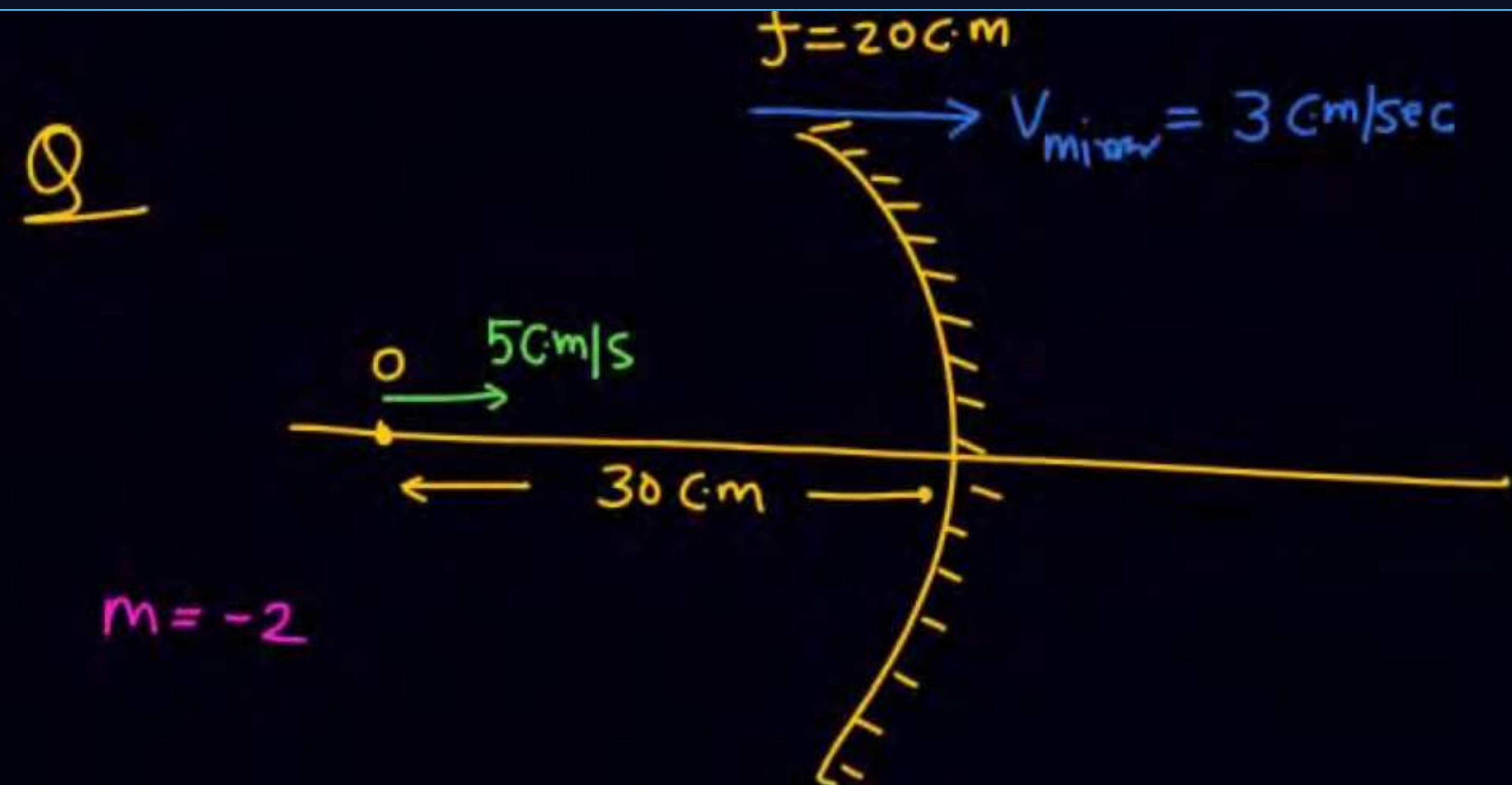

Solⁿ

$$\vec{V}_{I/m} = -m^2 \vec{V}_{O/m}$$

$$\vec{V}_I - \vec{V}_m = -m^2 (\vec{V}_O - \vec{V}_m)$$

$$V_I - (+3\hat{i}) = -4 (+5\hat{i} - 3\hat{i})$$

$$V_I - 3 = -8$$

$$\boxed{V_I = -5\hat{i}}$$

ATDB.uno



Q

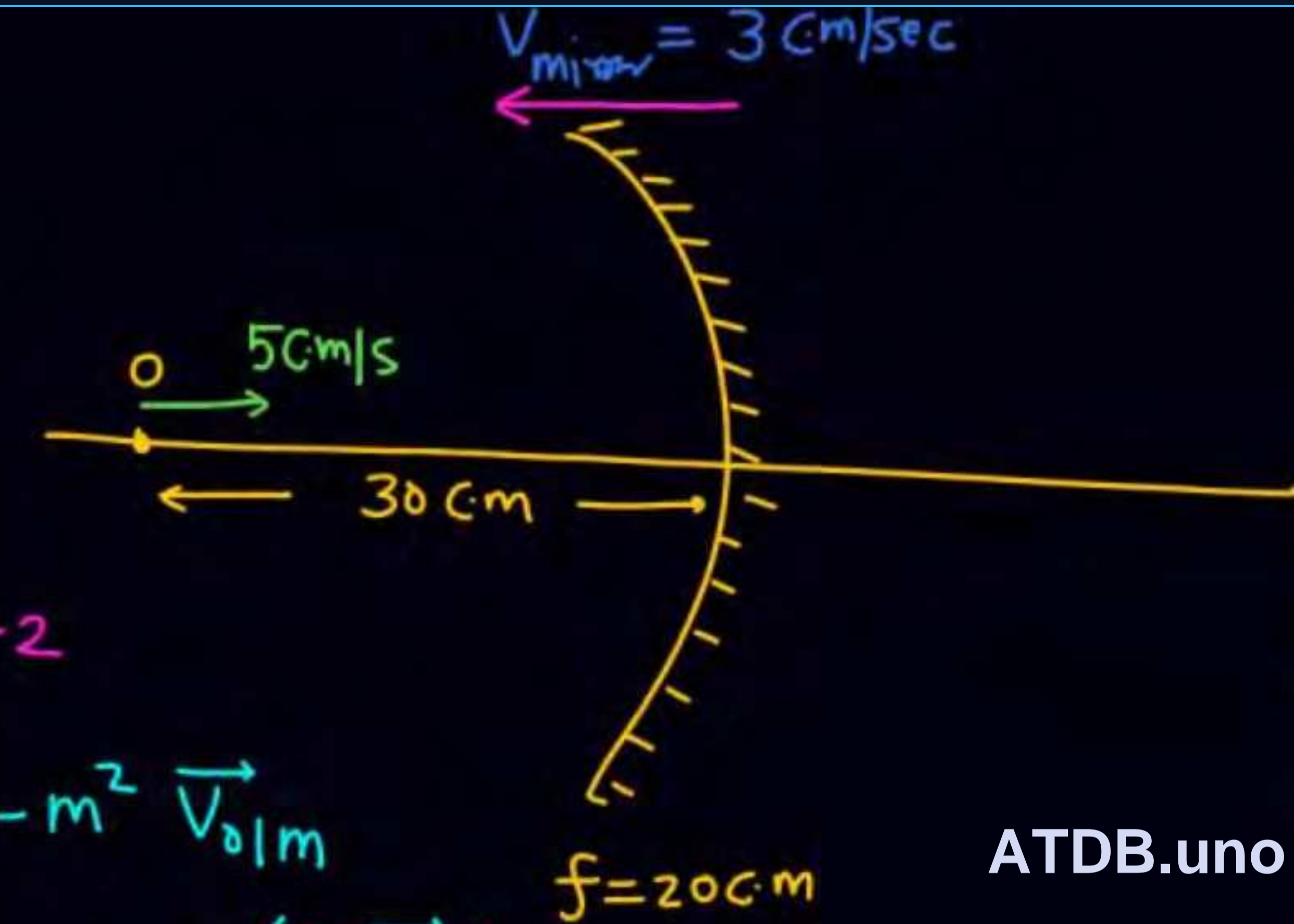

$$\vec{V}_{I/m} = -m^2 \vec{V}_{o/m}$$

$$\vec{V}_I - \vec{V}_m = -m^2 (\vec{V}_o - \vec{V}_m)$$

$$V_I - (-3) = -4 (5 - (-3))$$

$$V_I + 3 = -4 (8)$$

$$V_I = -35$$

ATDB.uno

$$V_I - (+5) = -4 (-4 - 5)$$

$$V_I - 5 = 36$$

$$V_I = 41$$

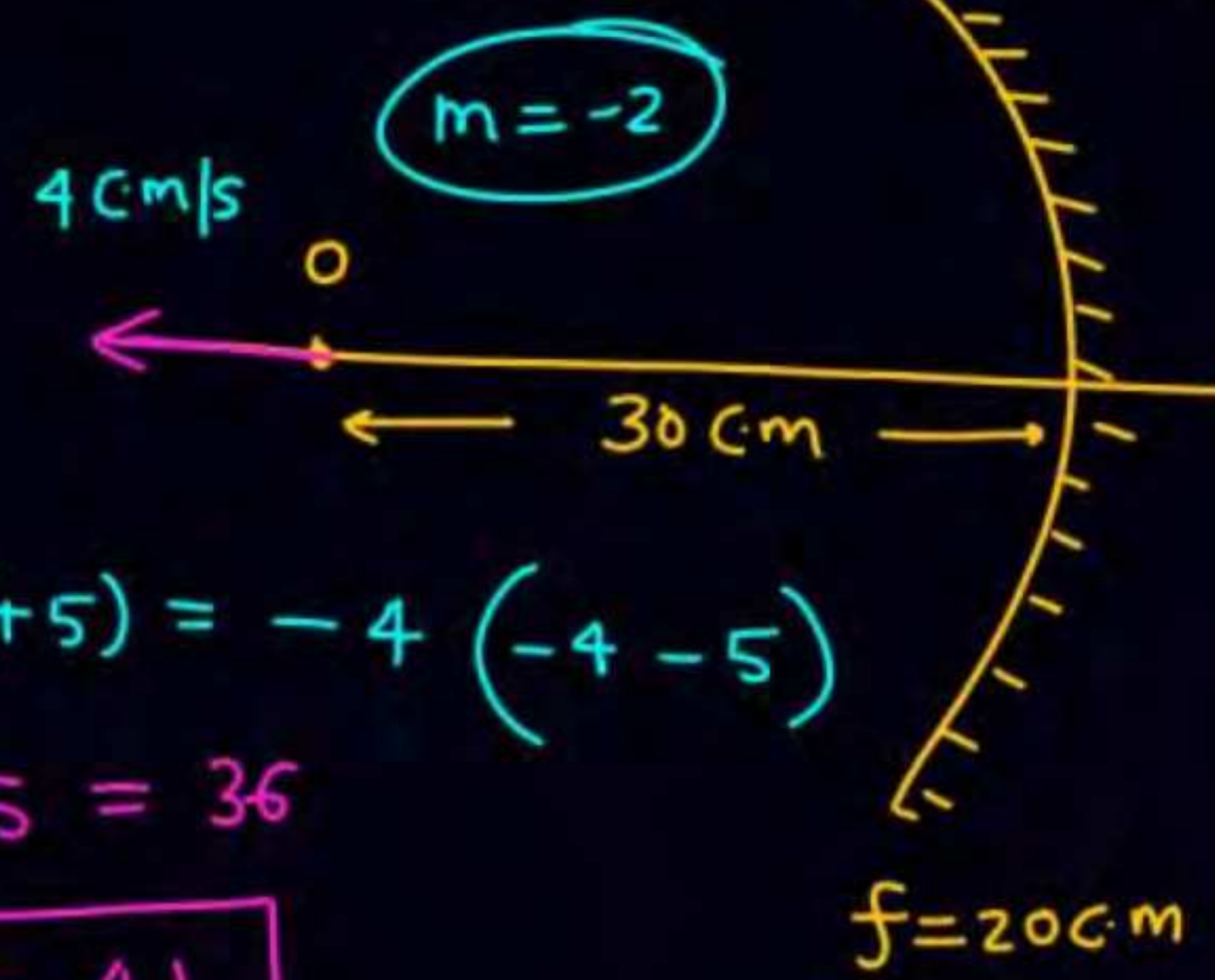

Q find velocity of image in mirror at $t=2$ sec

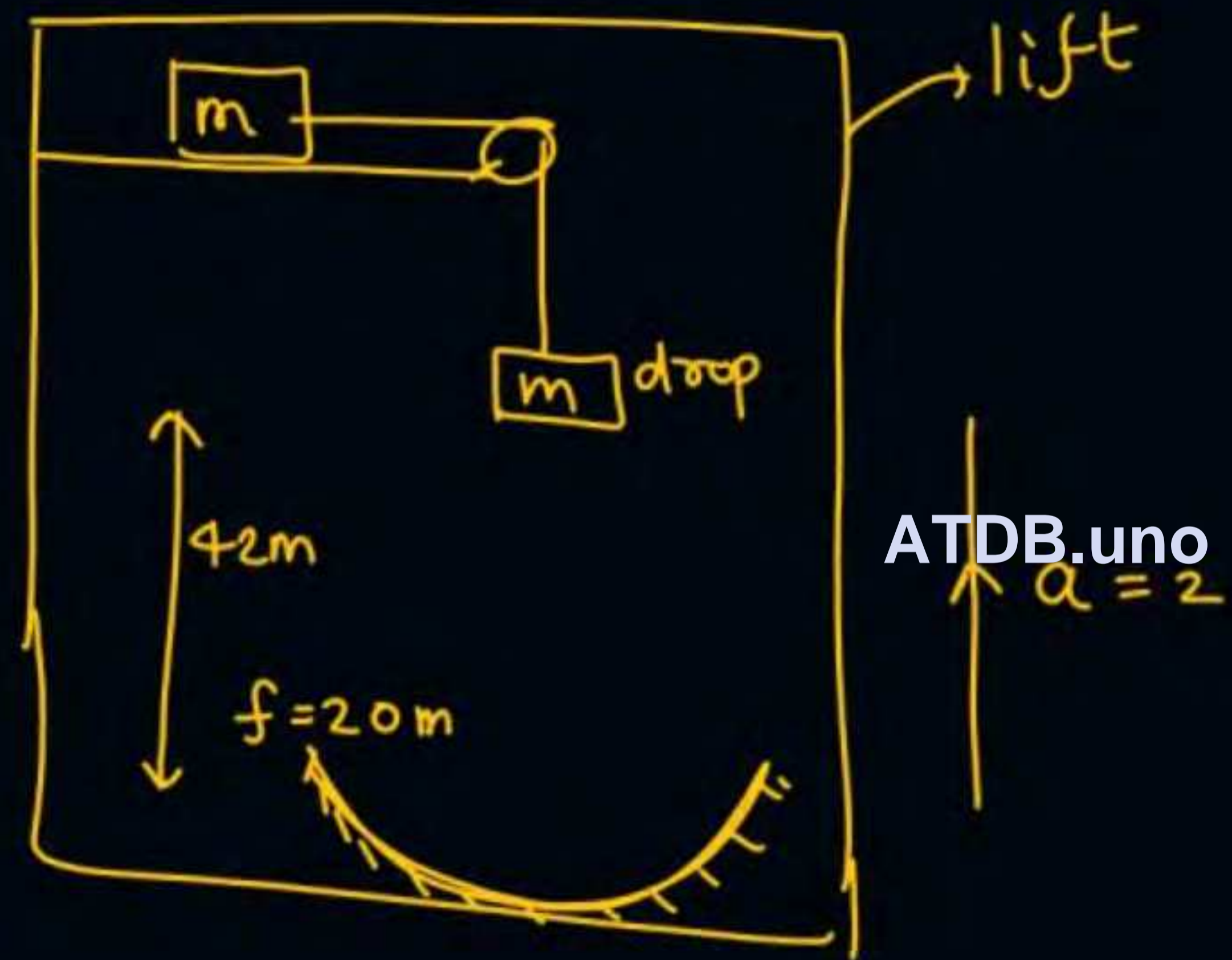

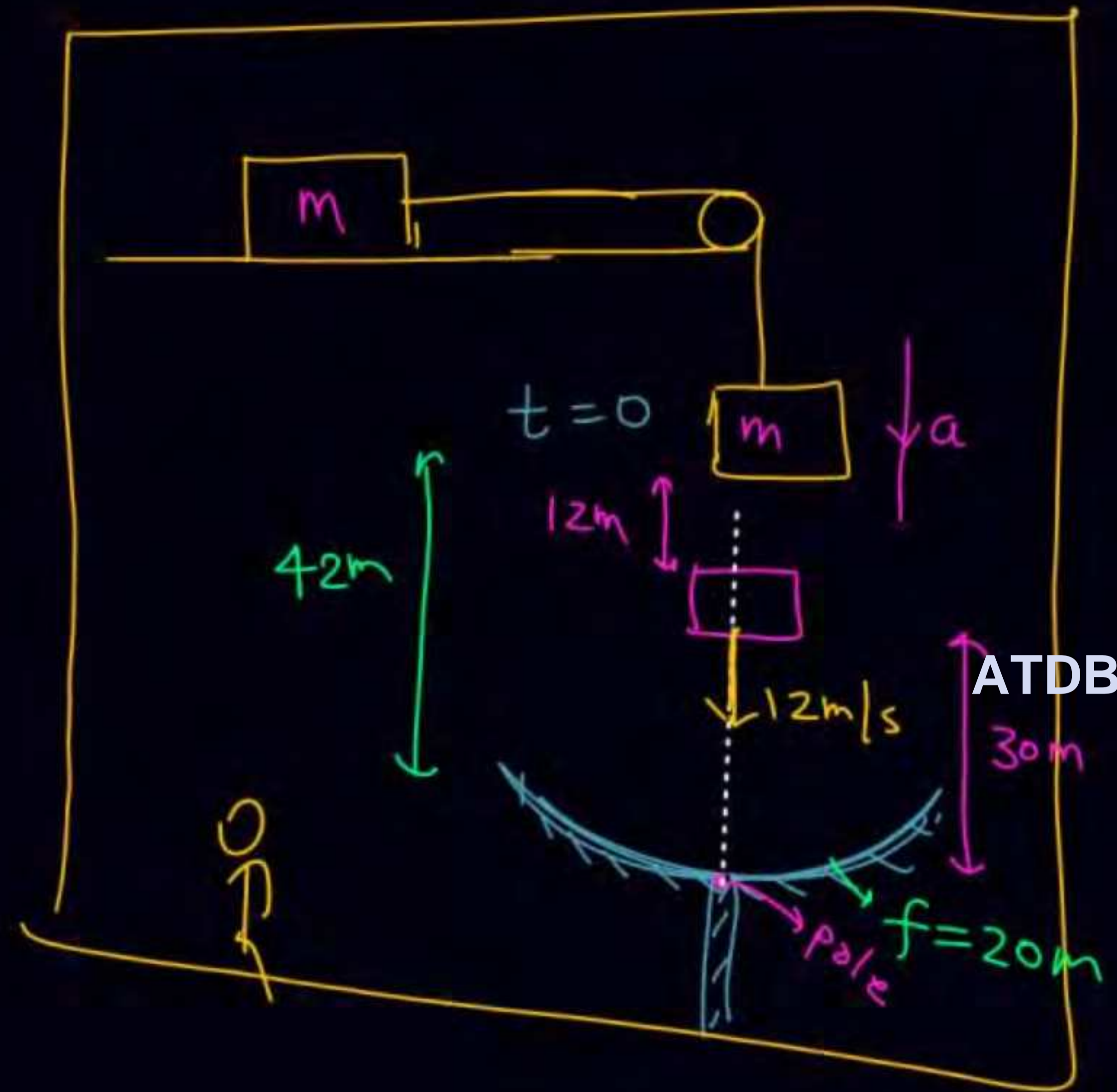

ATDB.uno

$$a = \frac{mg - 0}{2m} = g/2 \quad g_{\text{eff}}$$

$$a_{\text{rel}} = 2$$

$$a = \frac{12}{2} = 6$$

find velocity of image

$$s = 0 + \frac{1}{2} \times 6 \times 2^2 = 12 \quad \text{at } t = 2 \text{ sec}$$

$$Q_I = -m^2 V_o = -m^2 (-12)$$

$$Q_I = 48$$

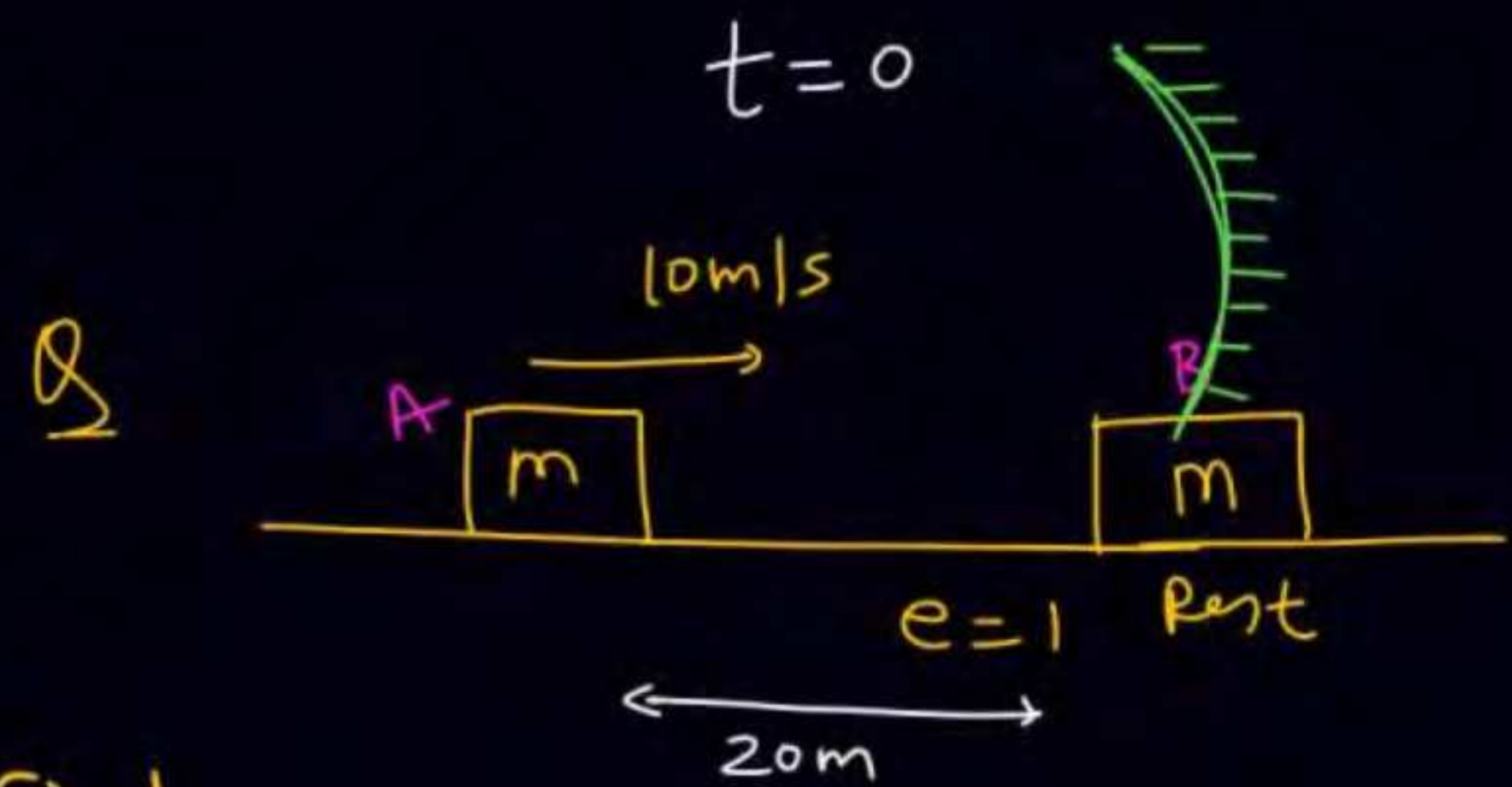

$$\vec{u}_{I/m} = -m^2 \vec{v}_{0/m}$$

$$u_I - (10) = -4(v_0 - 10)$$

find

velocity of image

at $t=5\text{sec}$

solⁿ

$t=5$ ATDB.uno

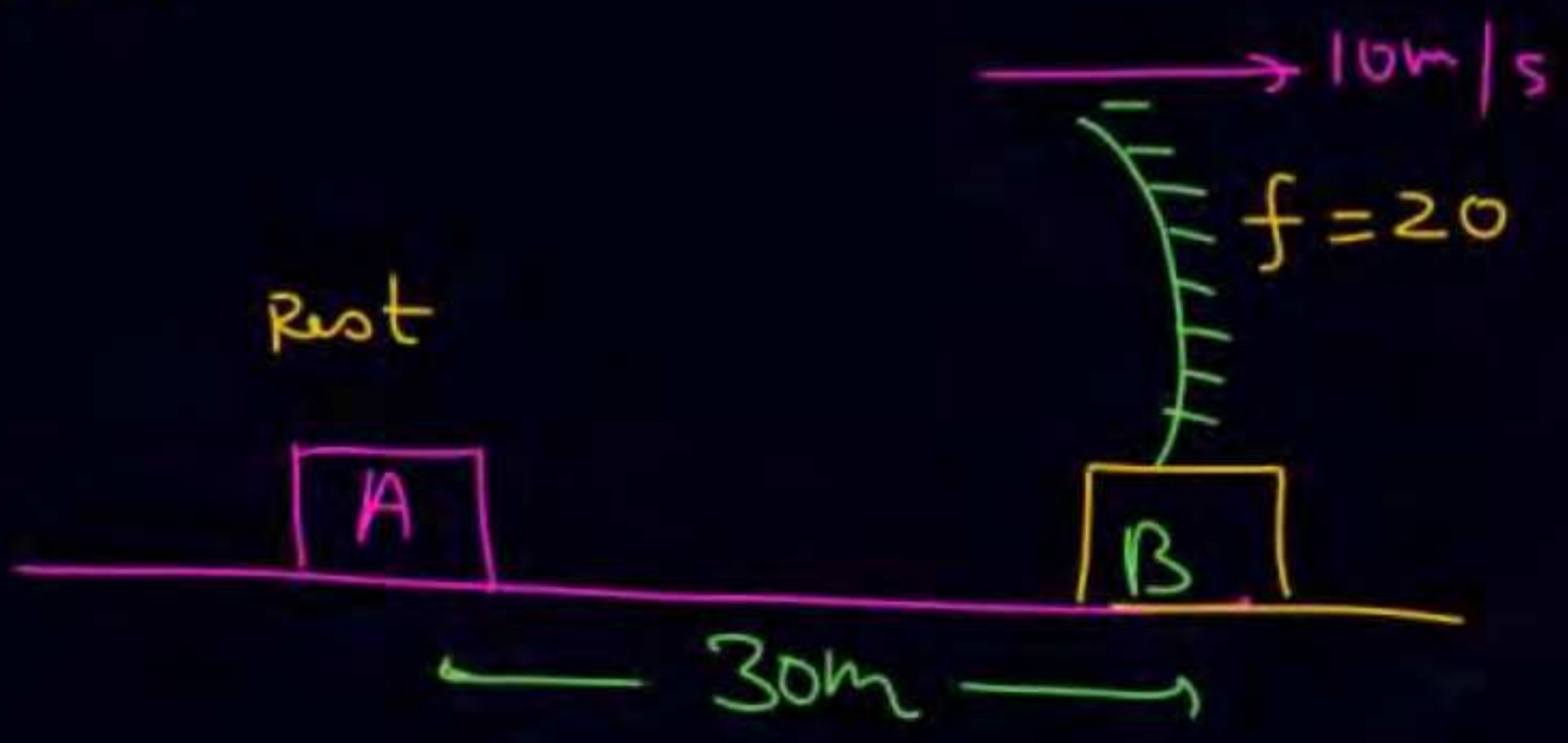



#

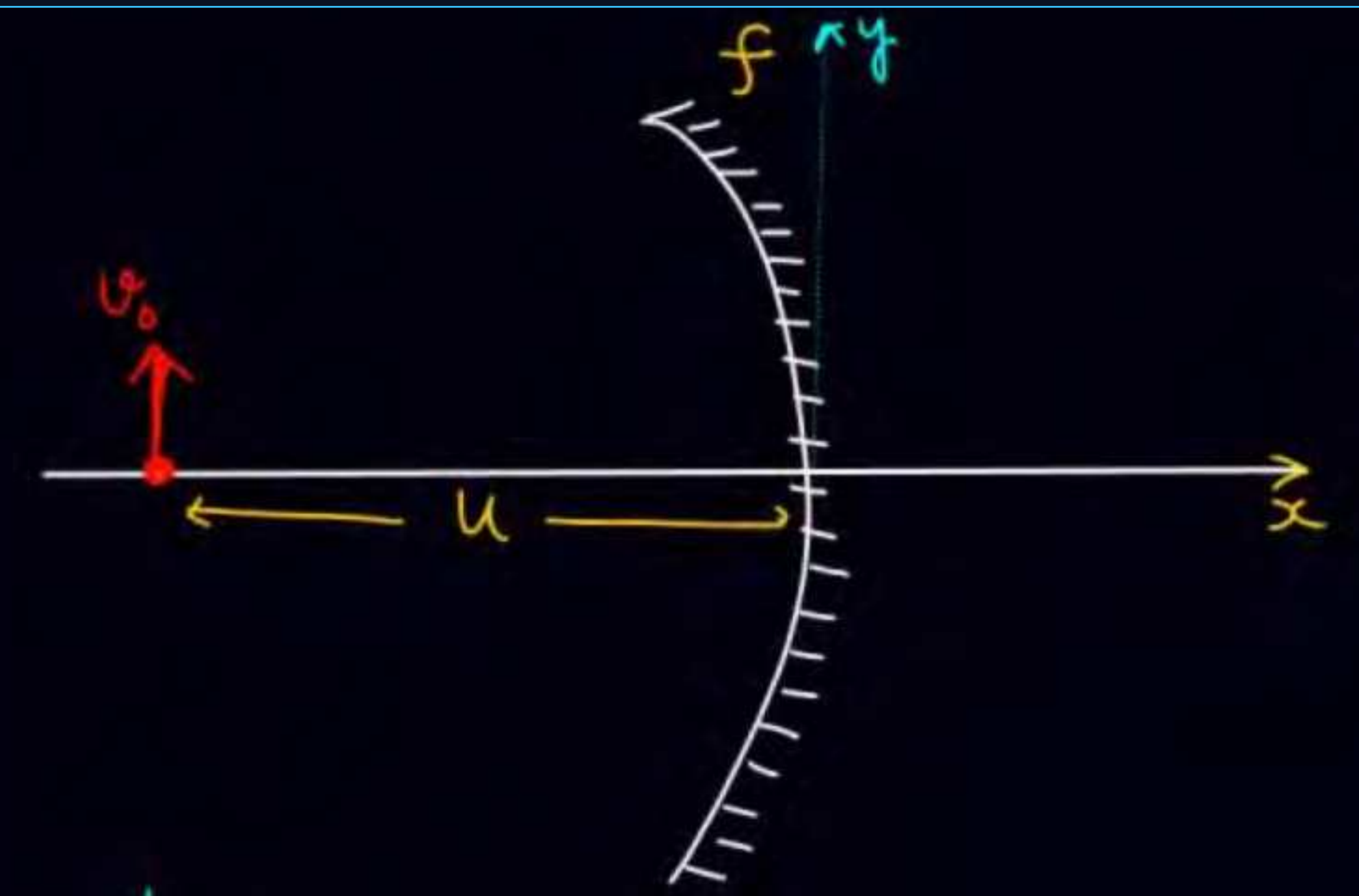

$$\frac{dh_I}{dt} = (v_I)_y = -\frac{v}{u} (v_0)_y$$

$$v_I = m v_0 \quad \left(\text{perpendicular to the P.A.} \right)$$

ATDB.uno $v_I = -m^2 v_0 \quad \left(\text{Along P.A.} \right)$

$$m = \frac{h_I}{h_0}$$

$$h_I = m h_0$$

$$\frac{dh_I}{dt} = m \frac{dh_0}{dt} + h_0 \frac{dm}{dt}$$

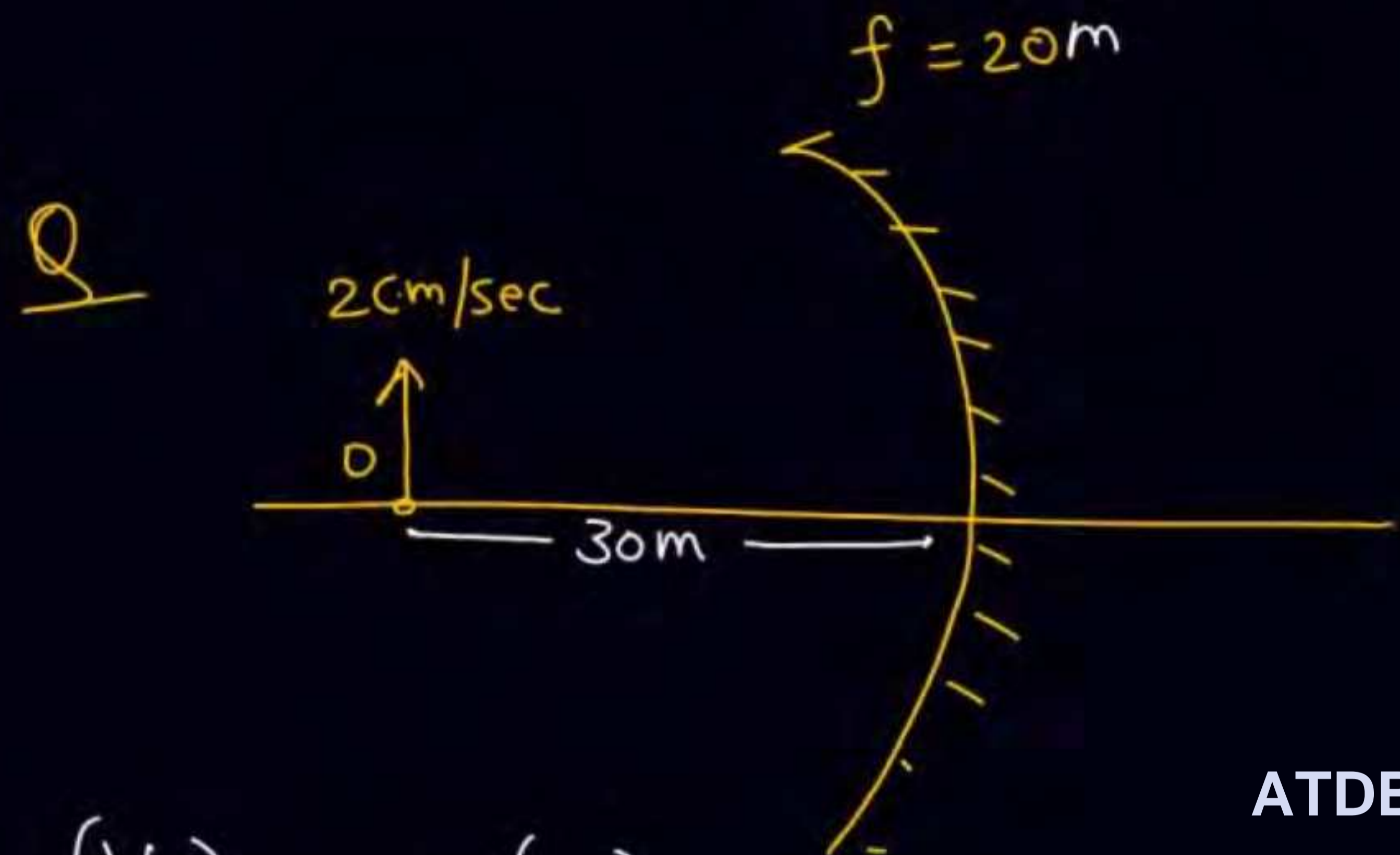

ATDB.uno

$$(V_I)_y = m(V_o)_y = (-2)(20\text{m/sec})\hat{j}$$

$$= -40\text{m/sec}$$

$\text{or } -40$

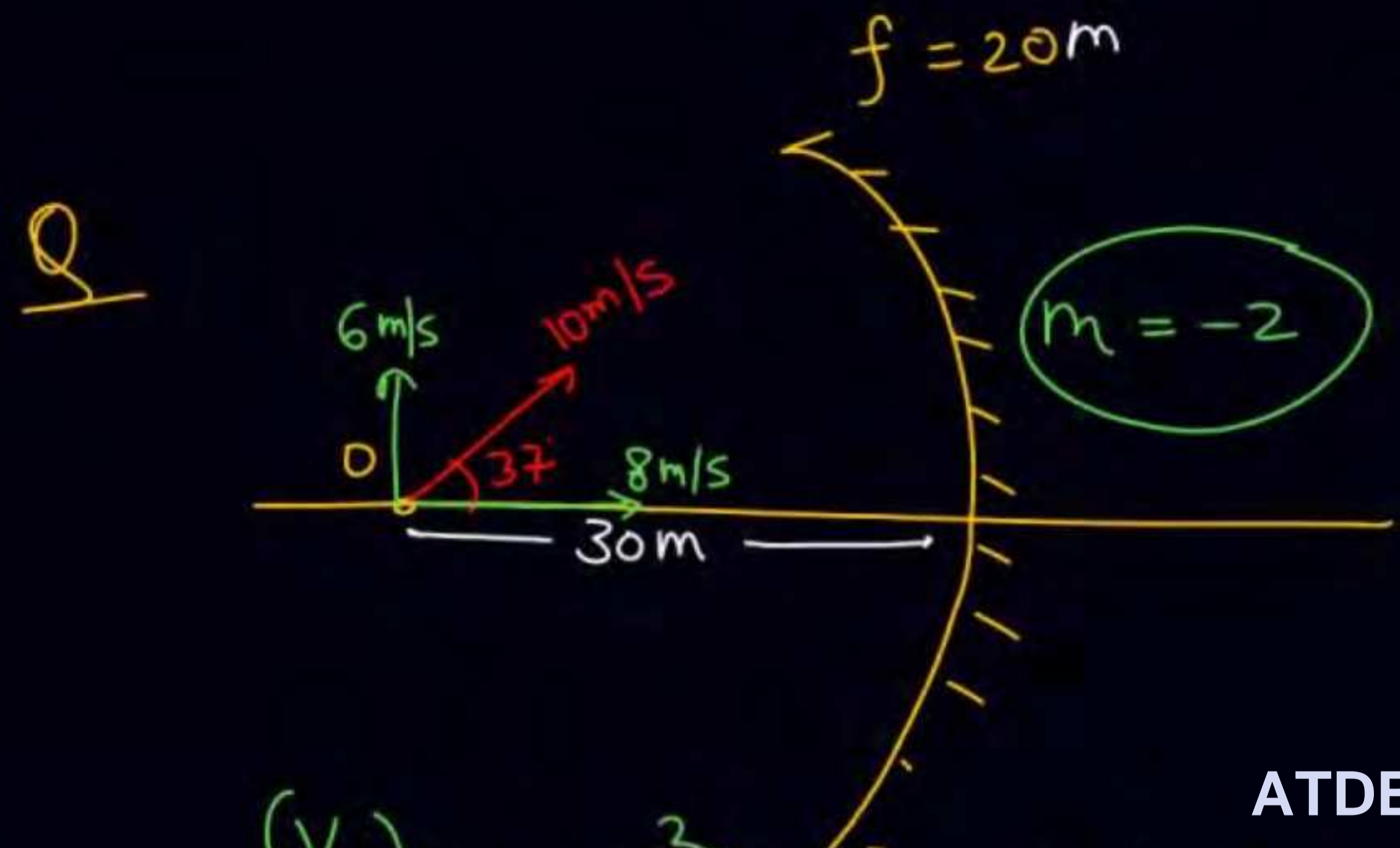

$$\vec{v}_I = -32\hat{i} - 12\hat{j}$$

ATDB.uno

$$(v_I)_x = -m^2 v_0 = -4 \times 8 = -32\hat{i}$$

$$(v_I)_y = m(v_0)_y = -2 \times (6) = -12\hat{j}$$



ATDB.uno

① find location of image after two reflection
 Consider 1st reflection at m_1 (left)

Ans 20 cm left to m_1 (left min)



SSSD

Q

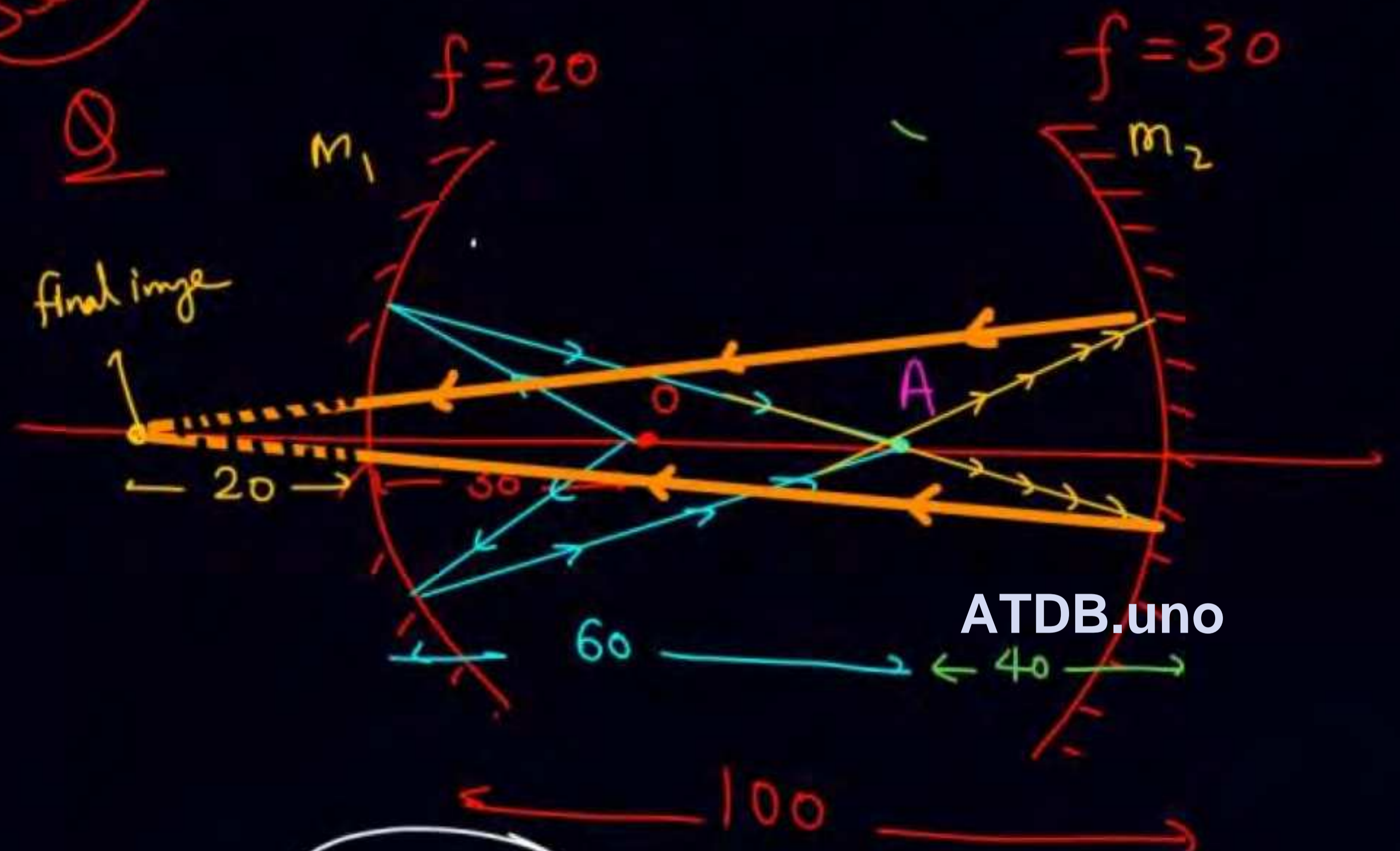

$m_1 = -2$

2nd reflection

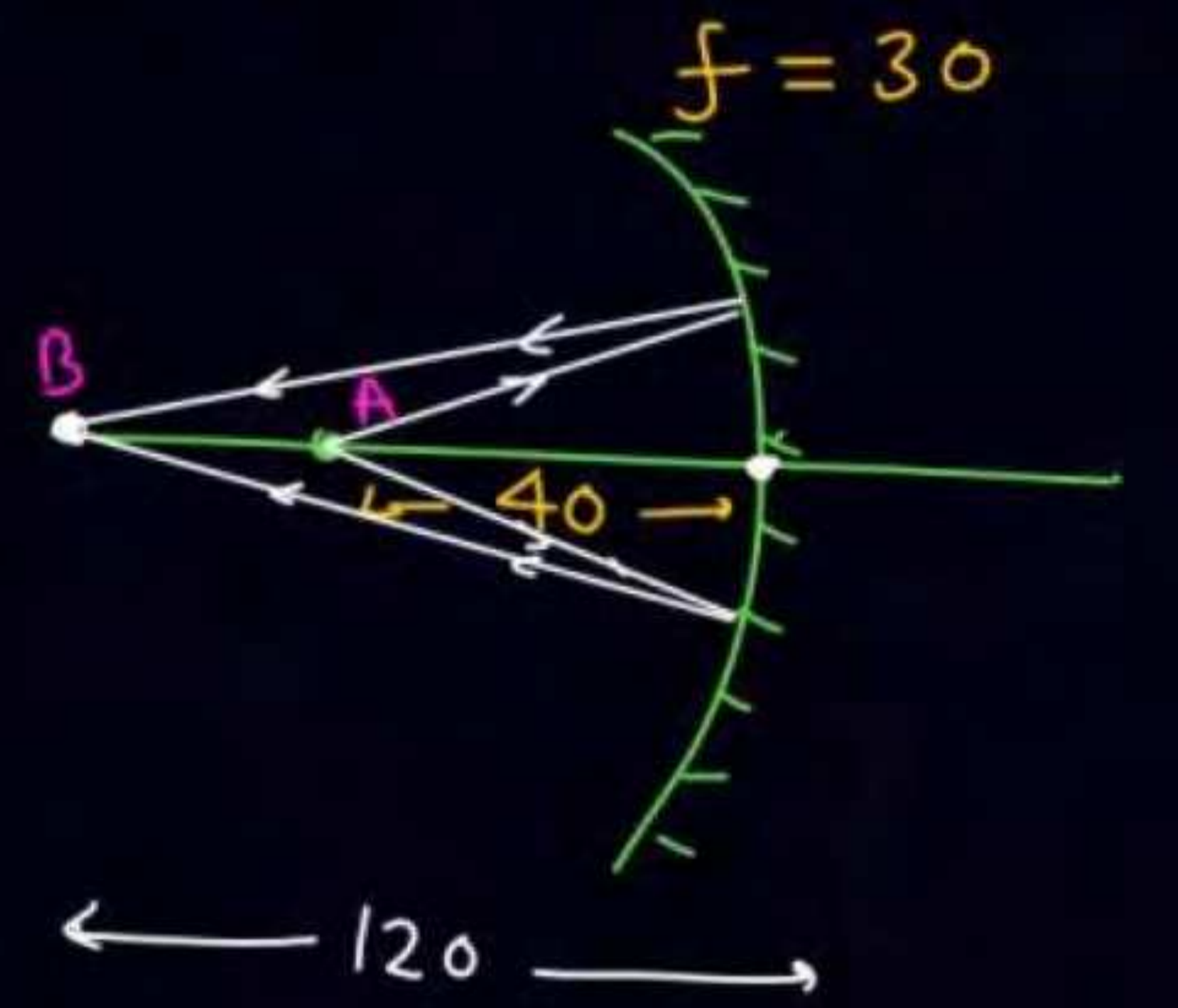

$m_2 = -\frac{-120}{-40} = -3$

ATDB.uno

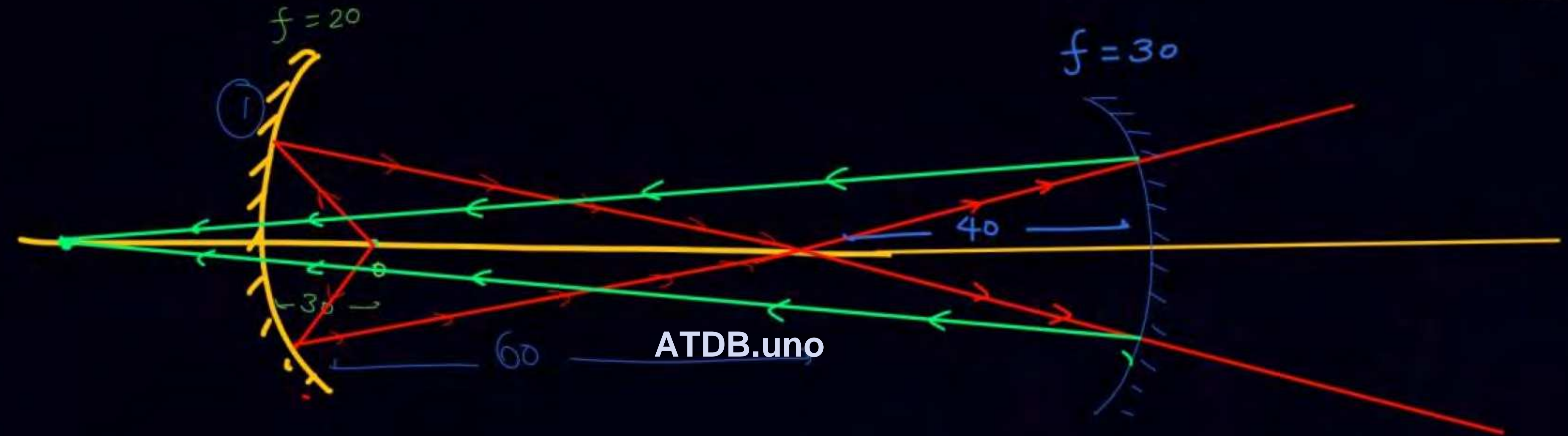

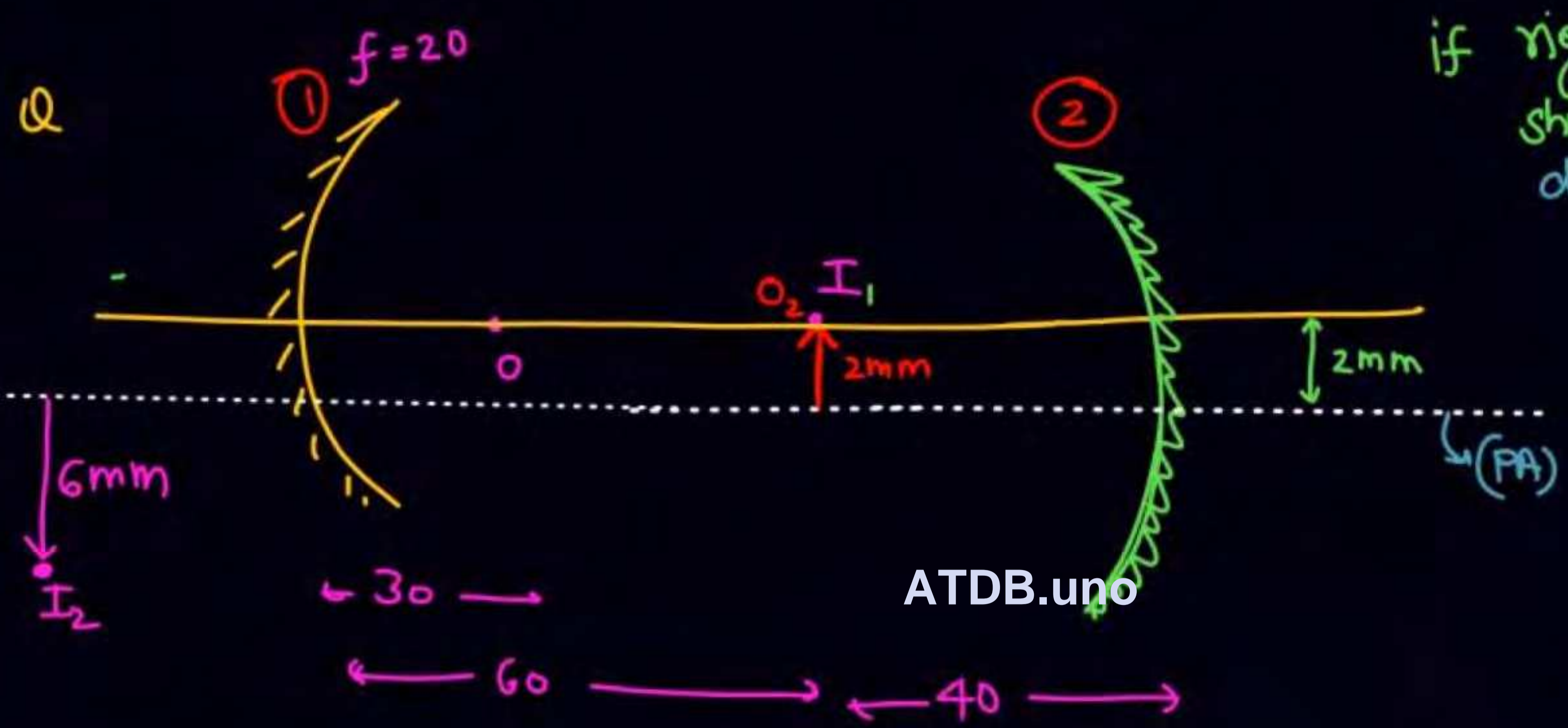

ATDB.uno

if right mirror is shifted by 2mm. down

2nd reflection

$$h_0 = 2\text{mm}$$

$$m_2 = -3$$

$$v = -120$$

$$u = -40$$

$$m = -\frac{v}{u} = -3$$

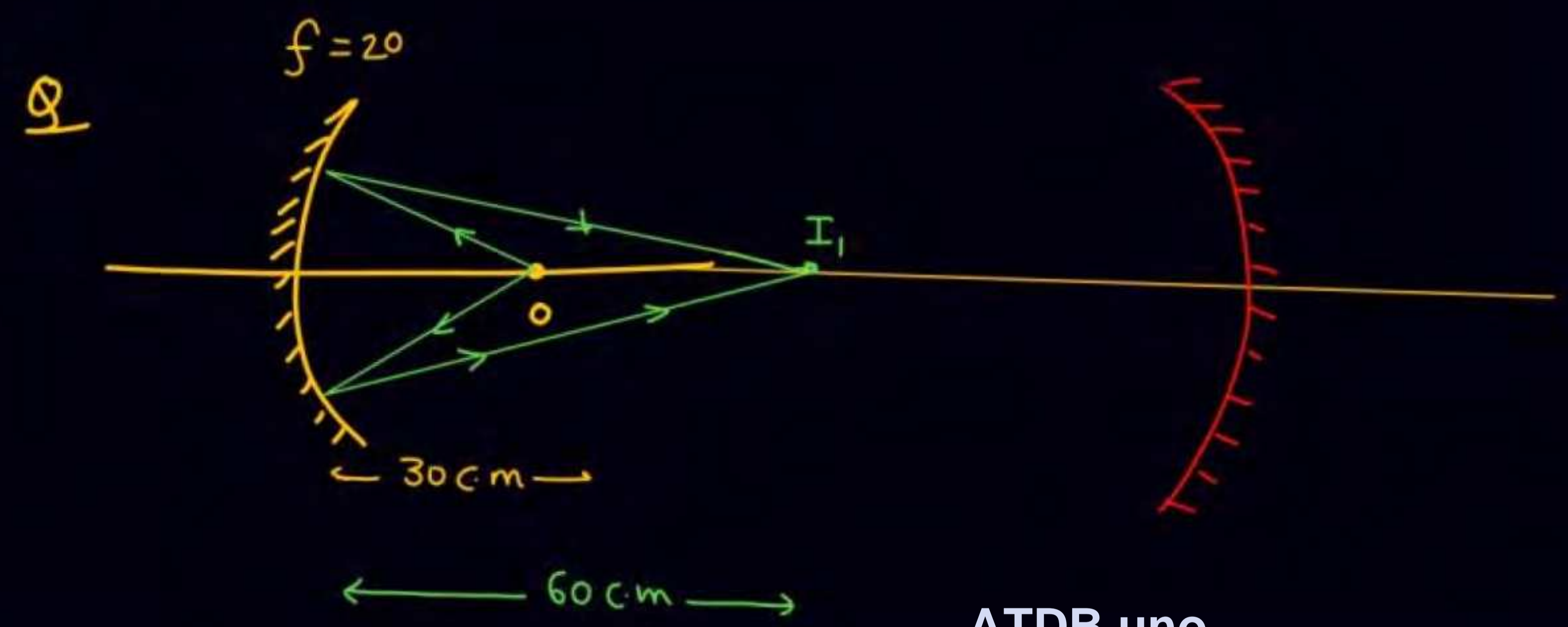

ATDB.uno

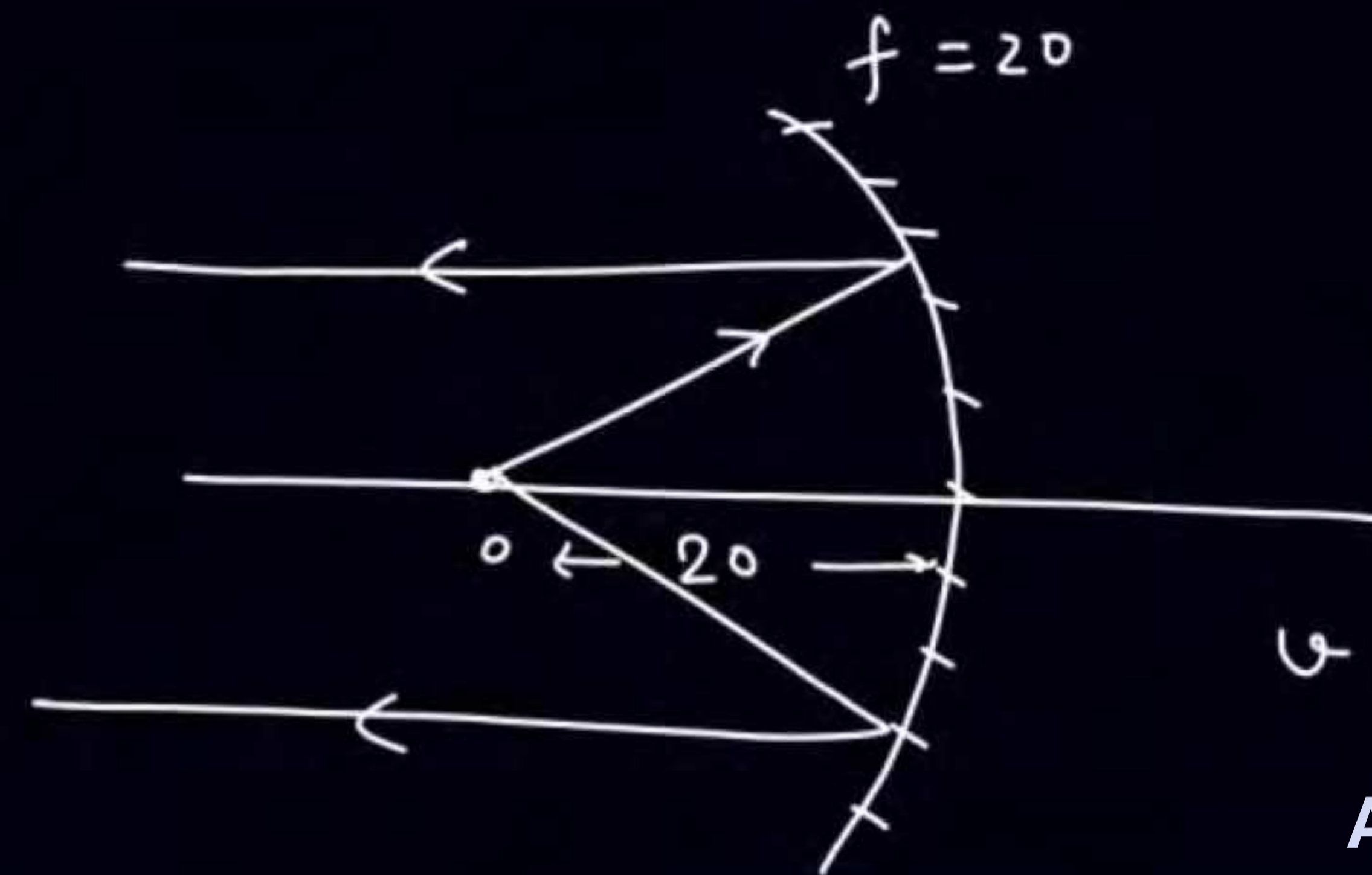

$$v = \frac{-20 \times -20}{(-20) - (-20)} = \infty$$

ATDB.uno

SSSD

Q

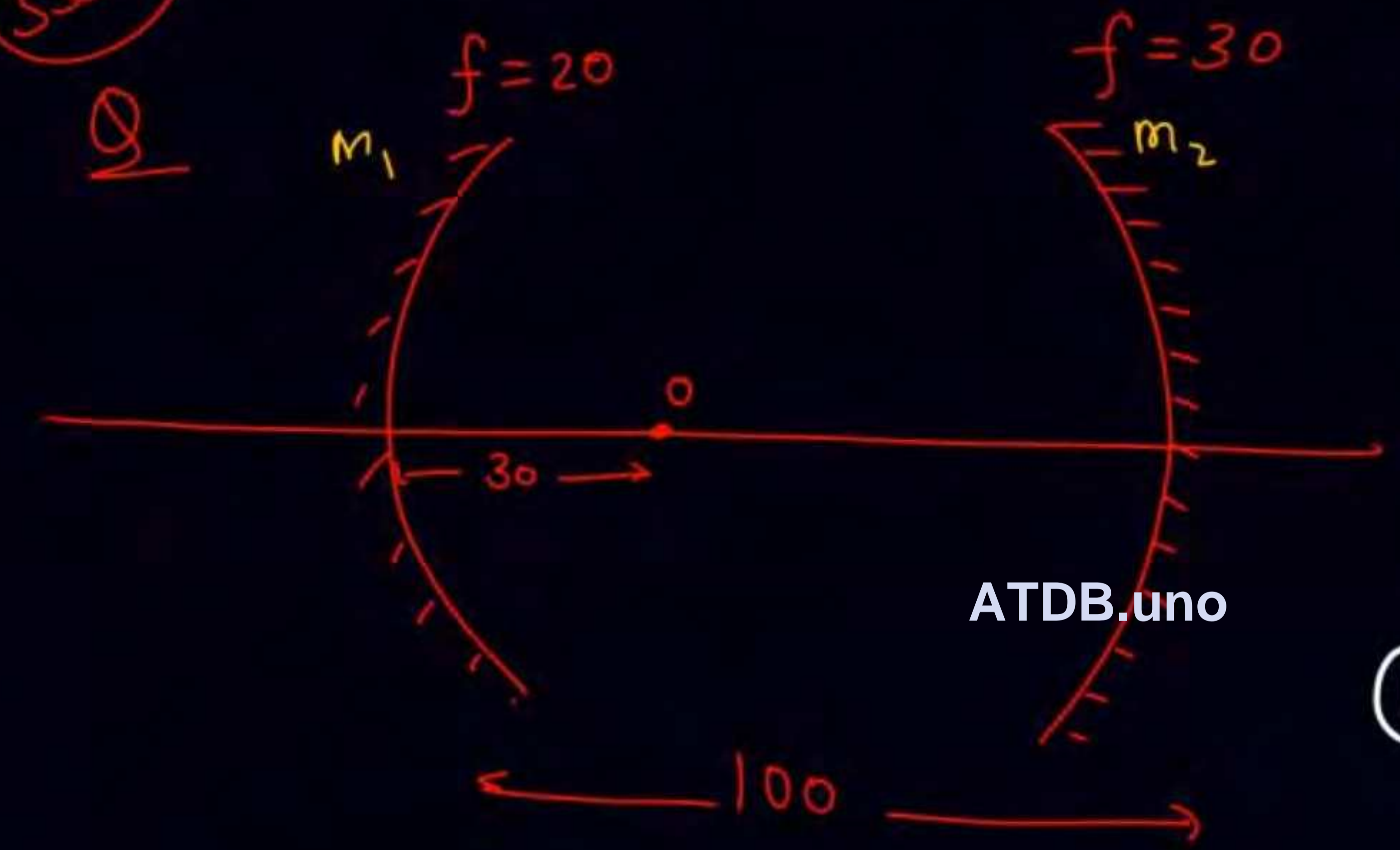

ATDB.uno



① find location of image after two reflection
 Consider 1st reflection at m_1 (left)

Ans 20 cm left to m_1 (left min)

② If obj is shifted above PA by 2mm find location of image & net magnification



SSSD

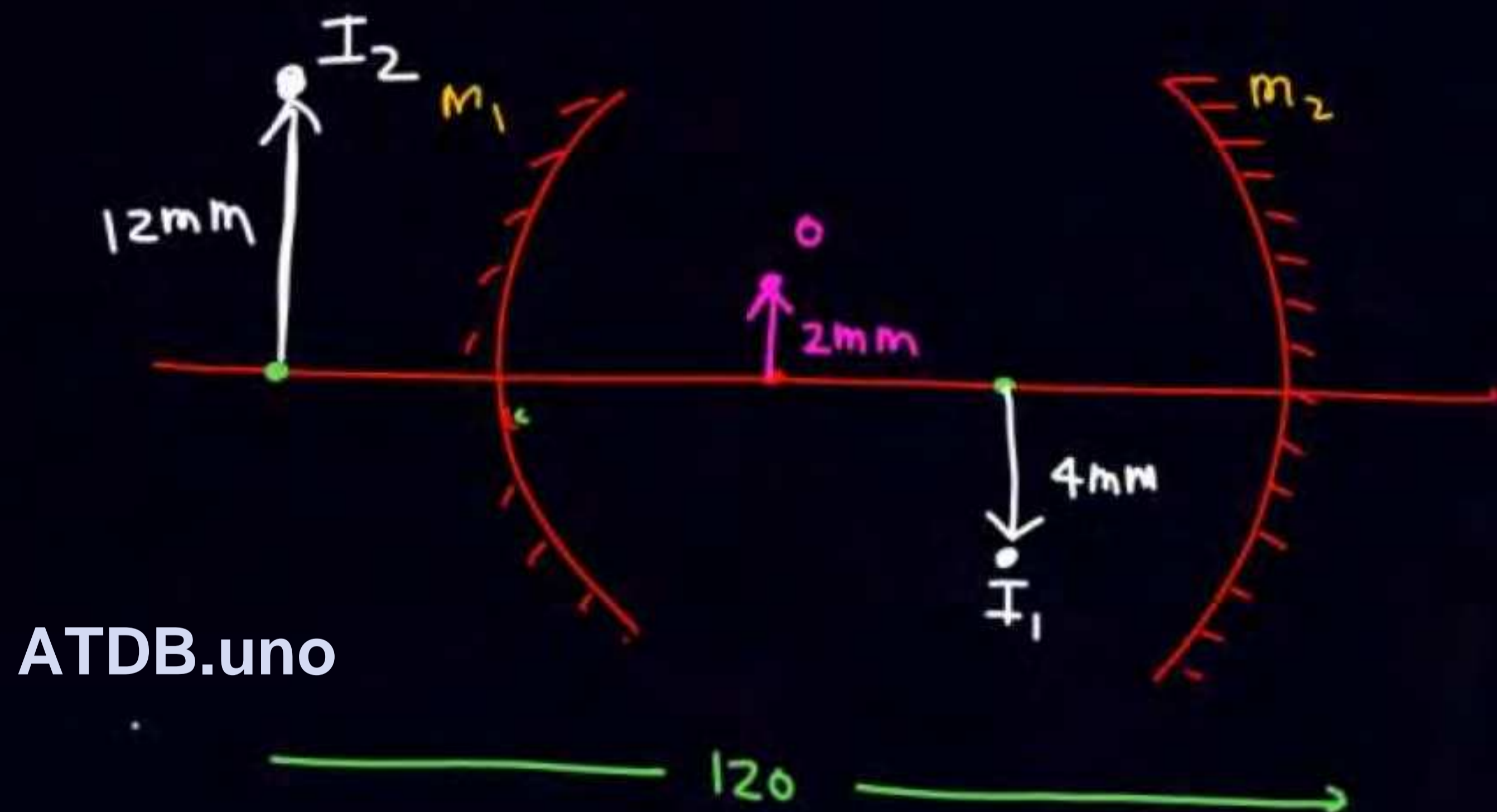
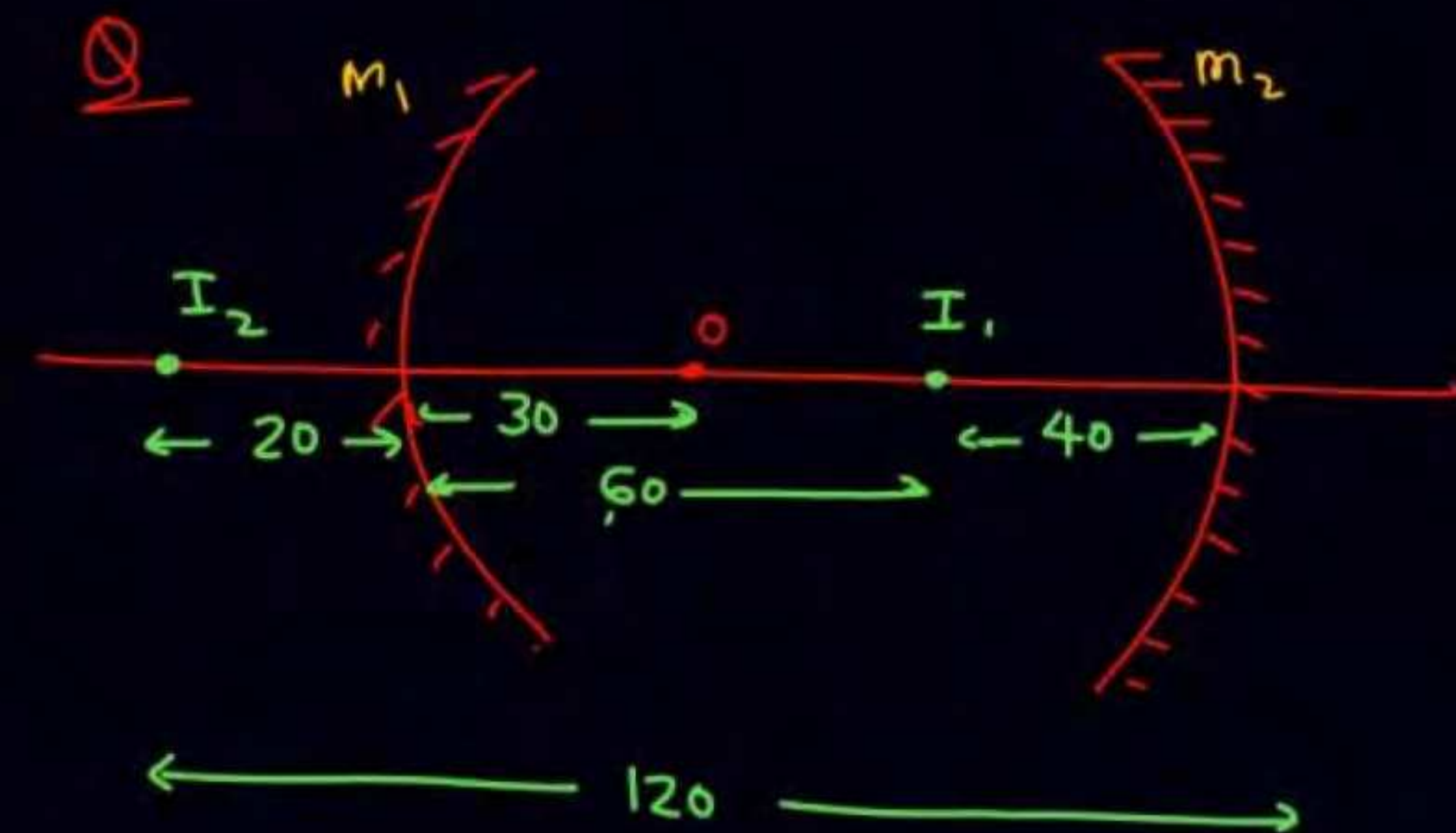

ATDB.uno

$$\left. \begin{array}{l} m_1 = -2 \\ m_2 = -3 \end{array} \right\} \text{magnified}$$

$$\begin{aligned} m_{nt} &= m_1 \times m_2 \\ &= (-2) \times (-3) = +6 \end{aligned}$$

Assume paraxial rays approx

Q

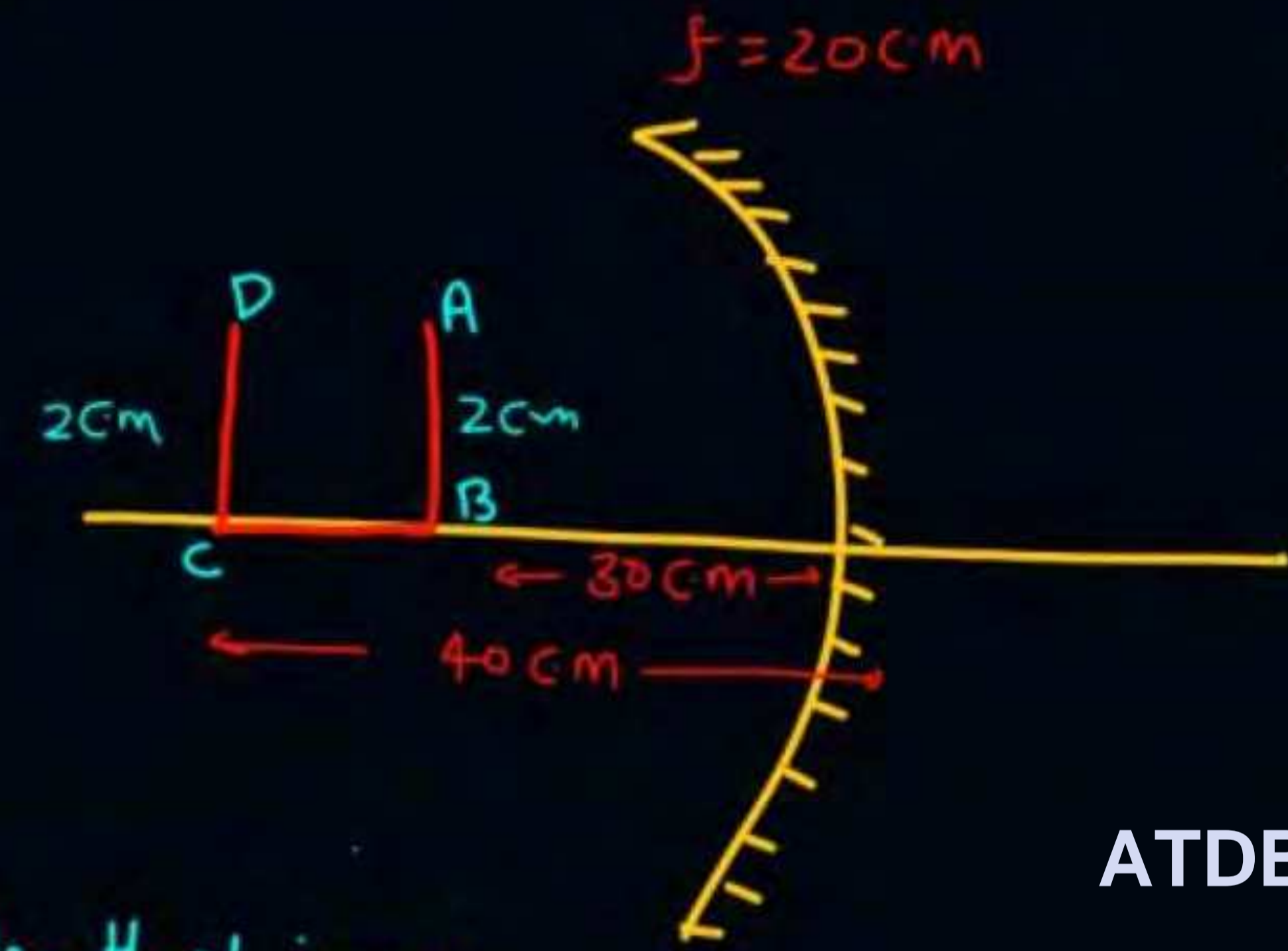

Solⁿ

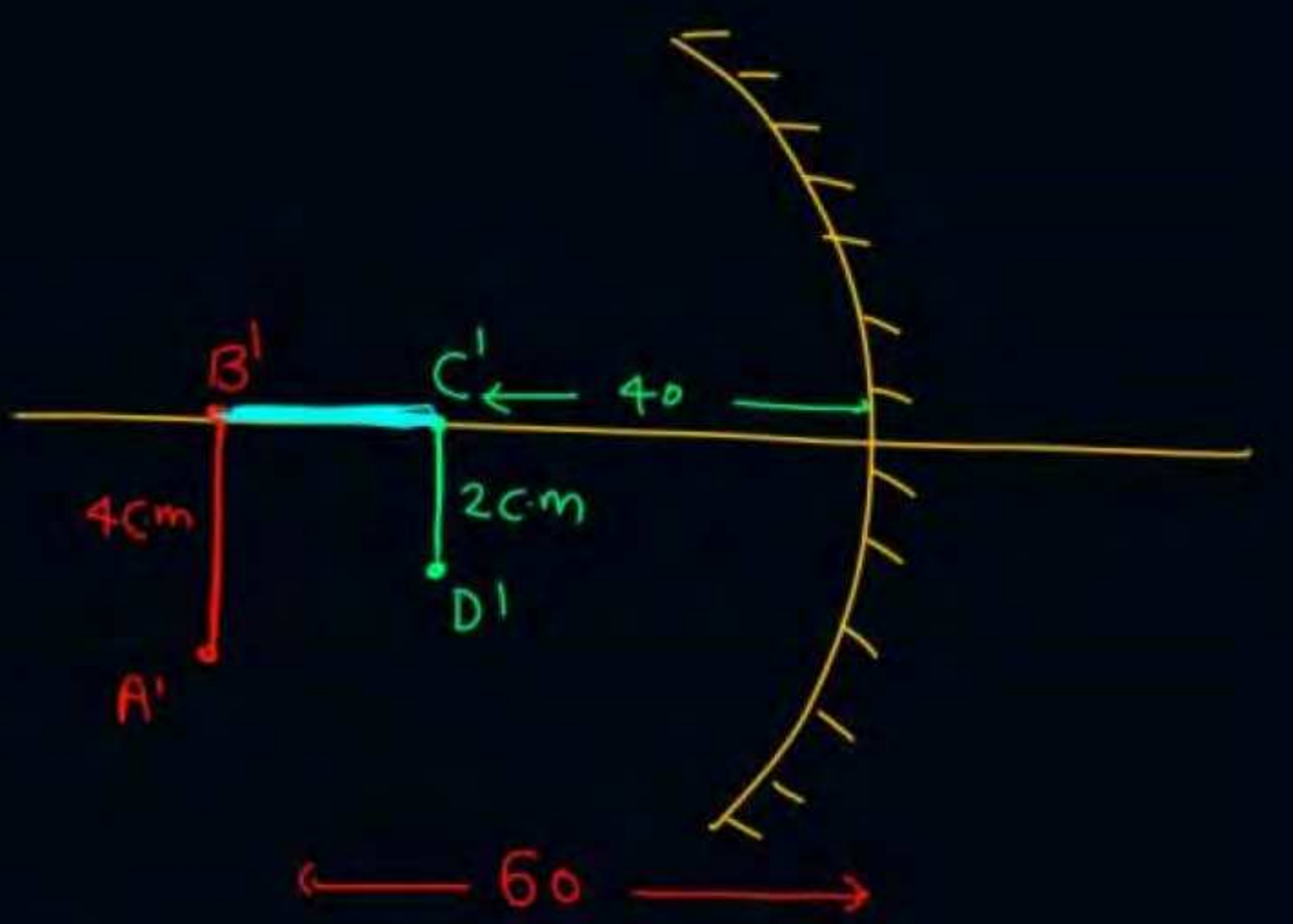

ATDB.uno

Find length of image

Length of image = $4 + 20 + 2 = 26\text{ cm}$

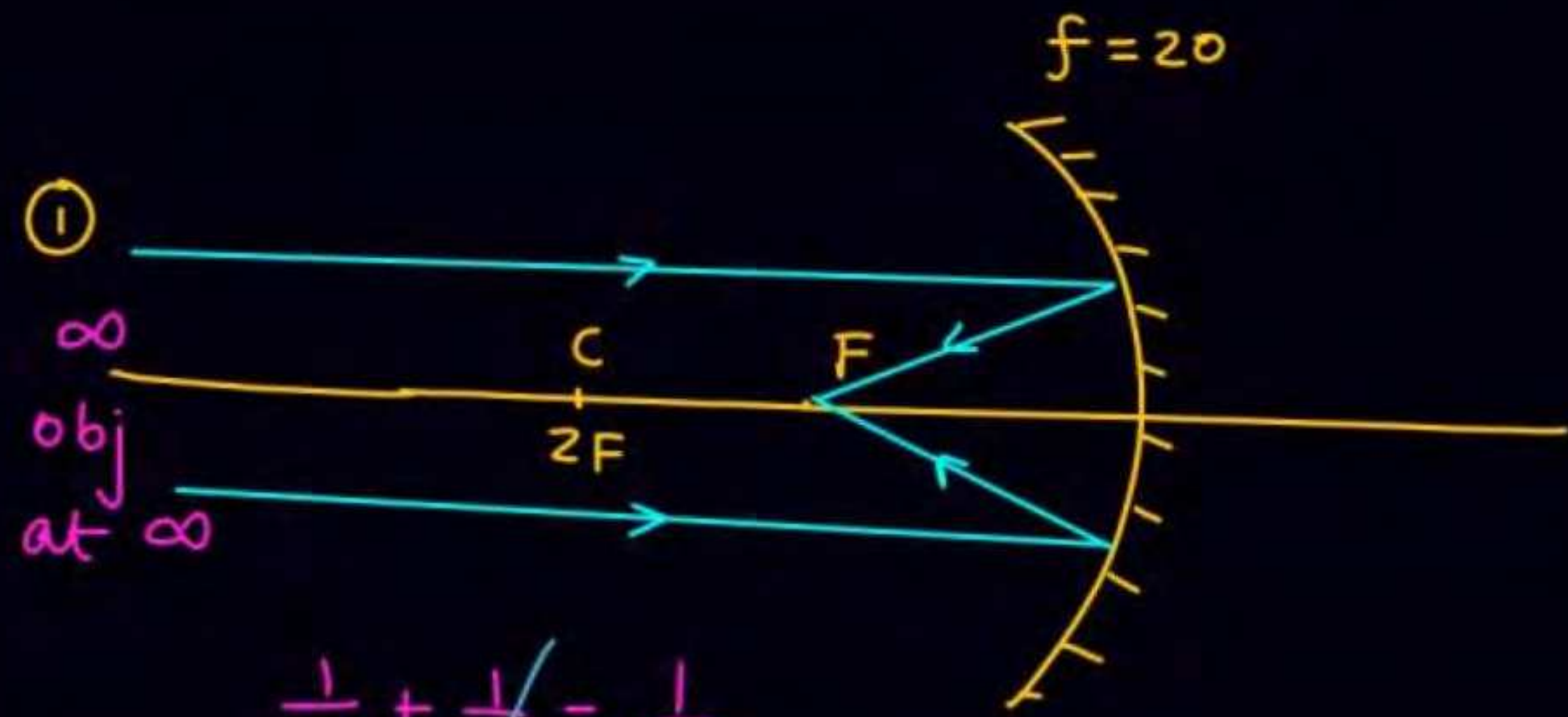

①
 ∞
 obj
 at ∞

$$\frac{1}{v} + \frac{1}{u} = \frac{1}{f}$$

$$v = -20$$

ATDB.uno

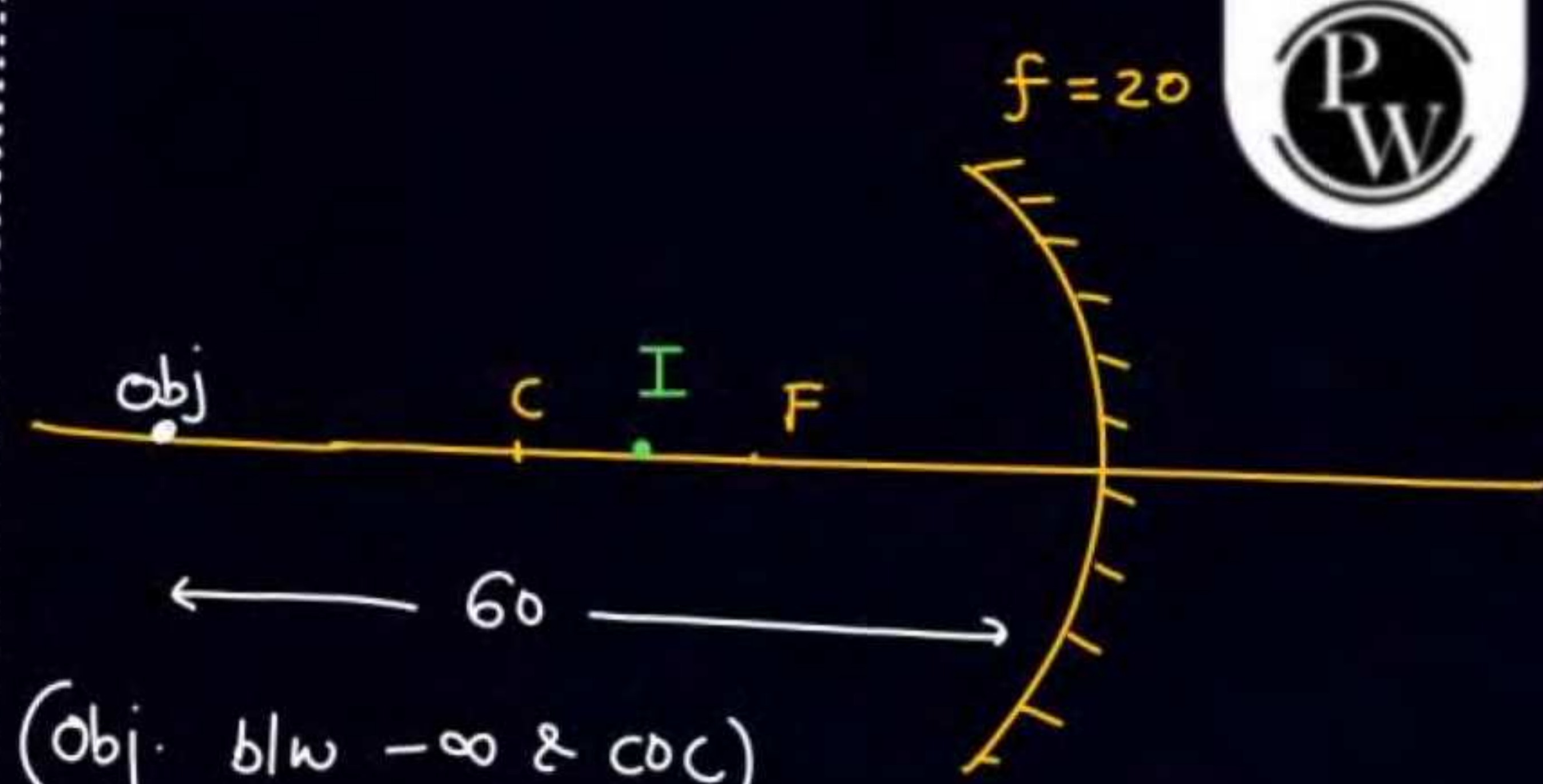

(obj. b/w $-\infty$ & CO)

R.O. $v = \frac{1200}{-60 - (-20)} = -30$

$$m = -\frac{v}{u} = -\frac{-30}{-60} = -\frac{1}{2}$$

(obj. b/w $-\infty$ & CO) \Rightarrow RO, RI, diminished, inverted
 image b/w F & C

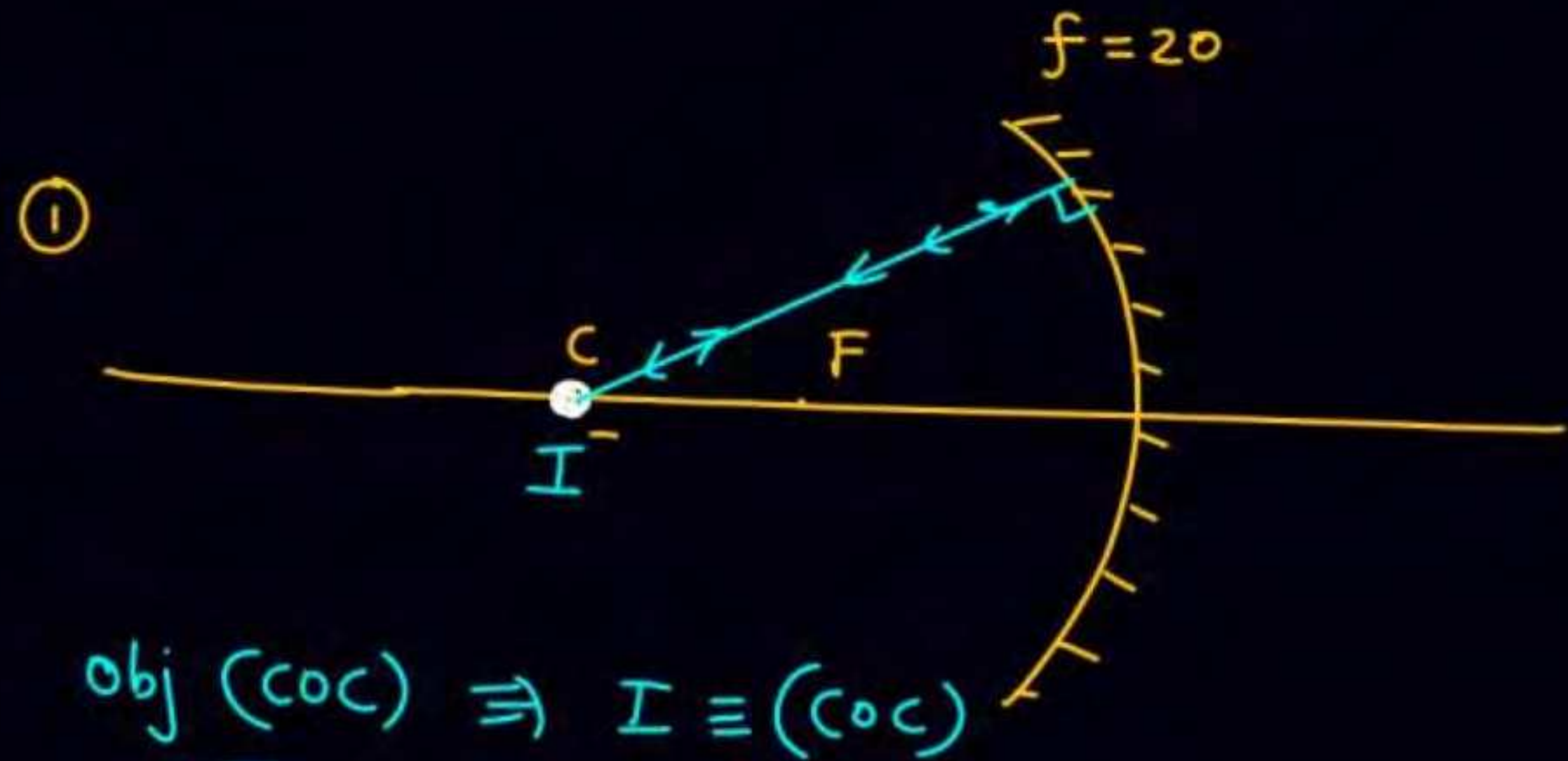

obj (COC) \Rightarrow I \equiv (COC)

$m = -1$

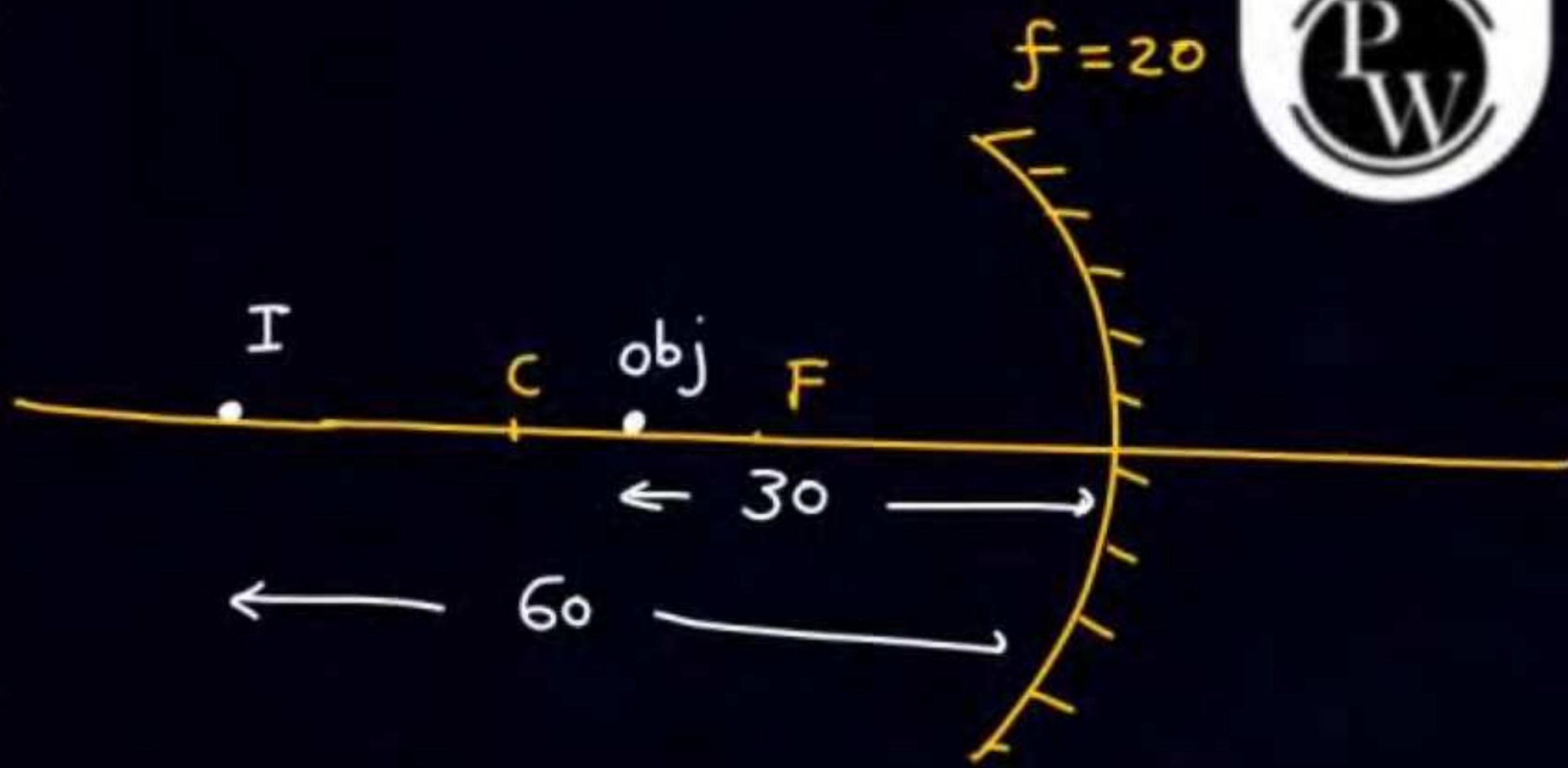

obj \equiv (b/w F & C)

Image \Rightarrow (b/w $-\infty$ & C) $m = -2$
 enlarge, inverted

ATDB.uno

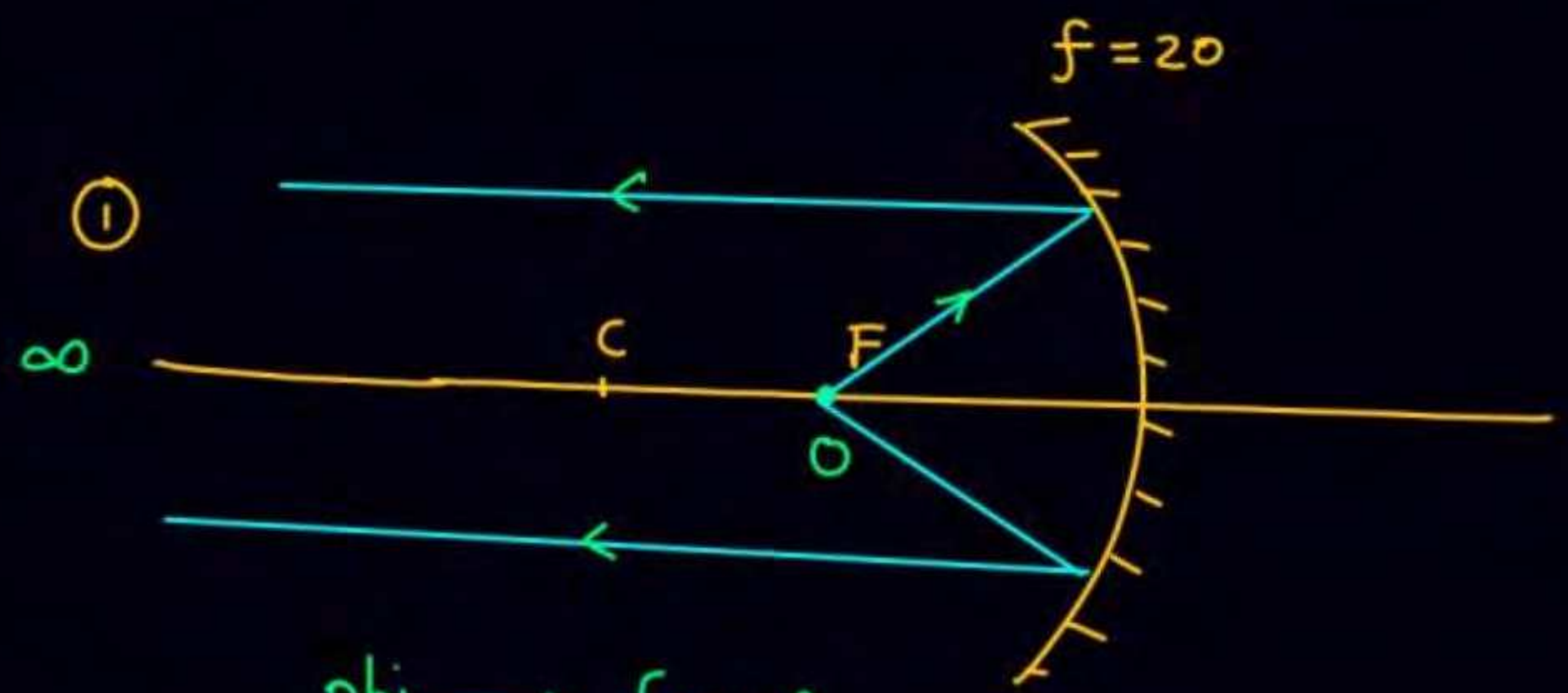

obj \rightarrow focus
 image $\rightarrow \infty$

ATDB.uno

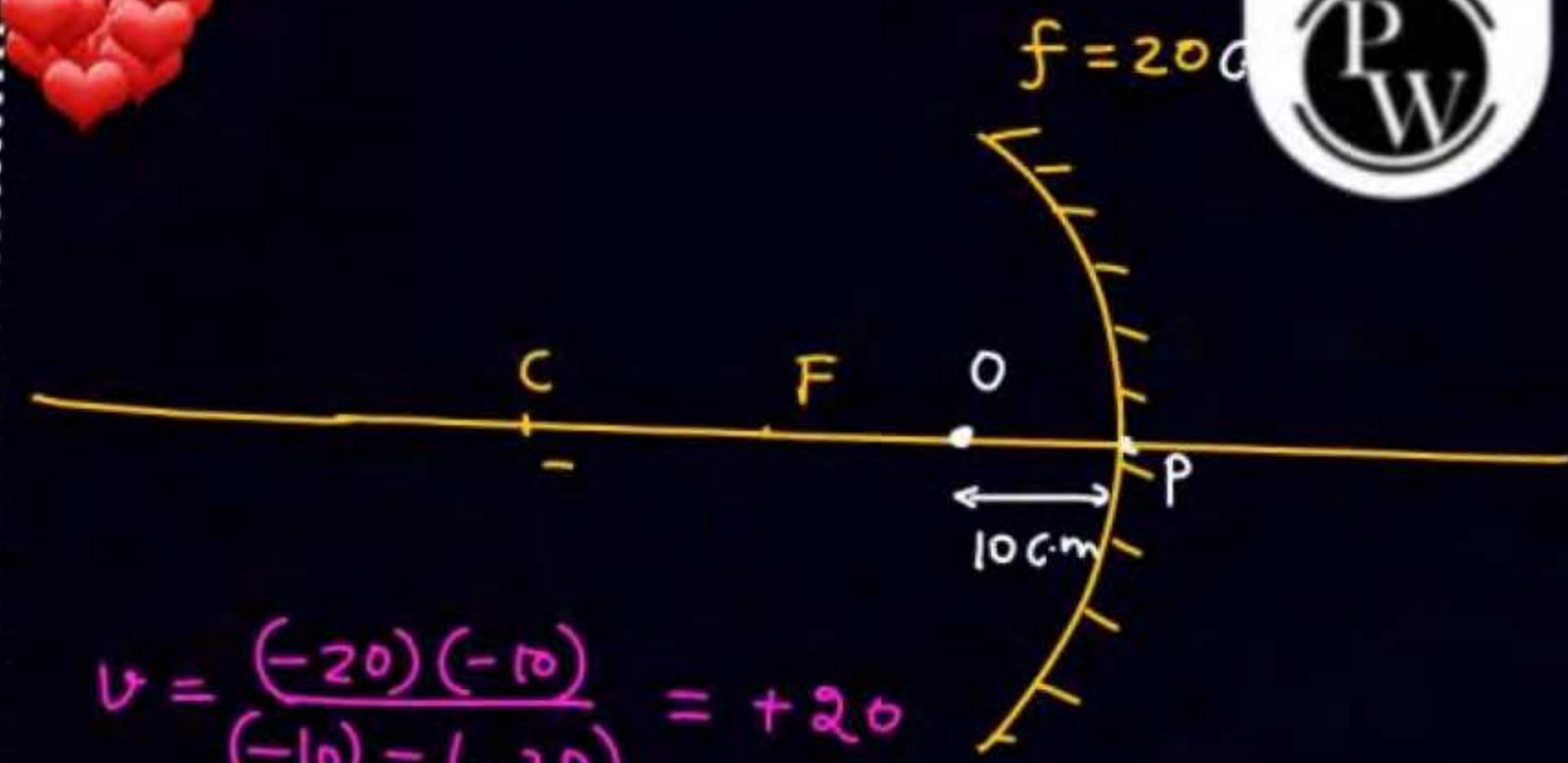

$$v = \frac{(-20)(-10)}{(-10) - (-20)} = +20$$

$$m = -\frac{20}{-10} = +2 \text{ (erect, enlarge)}$$

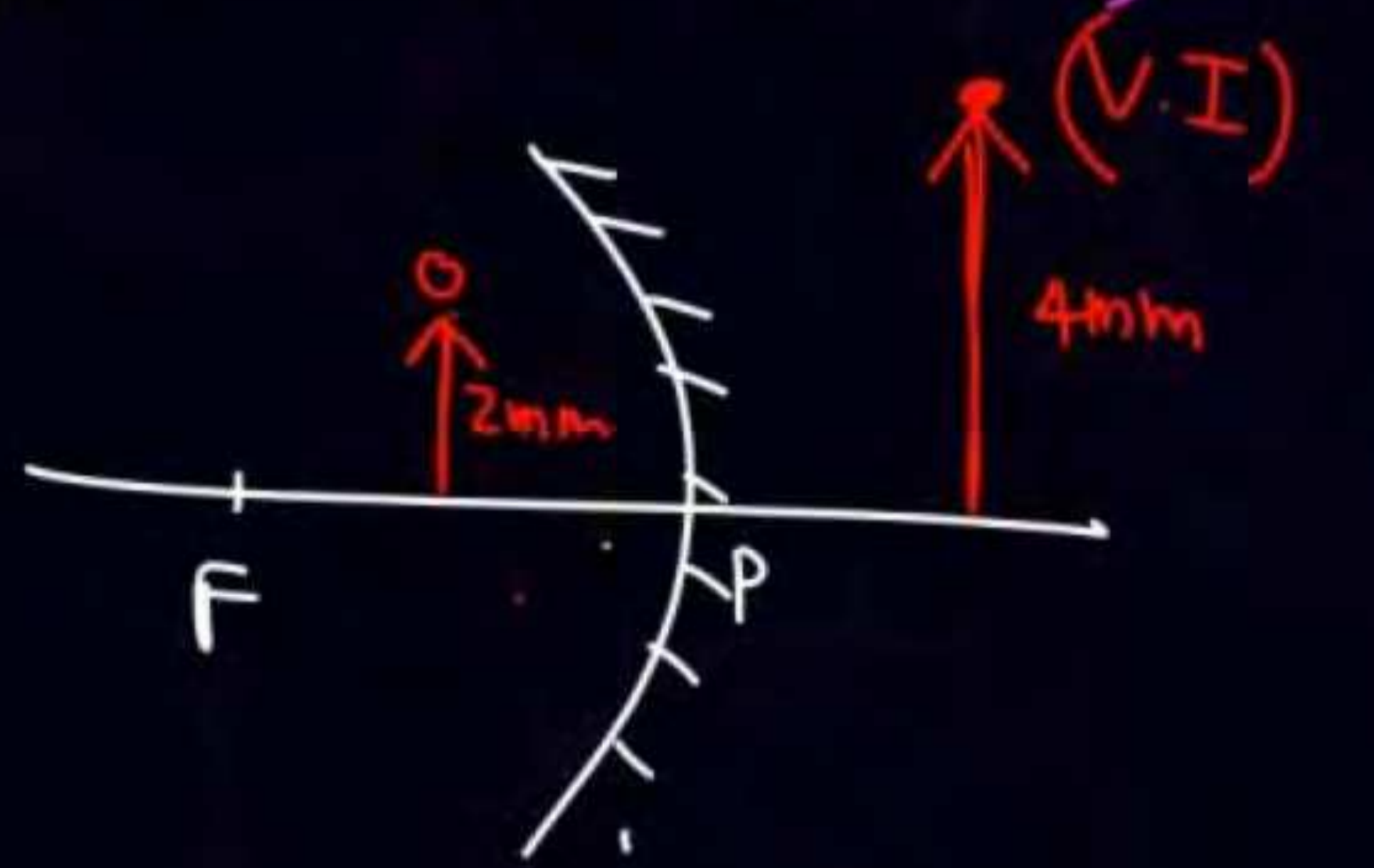

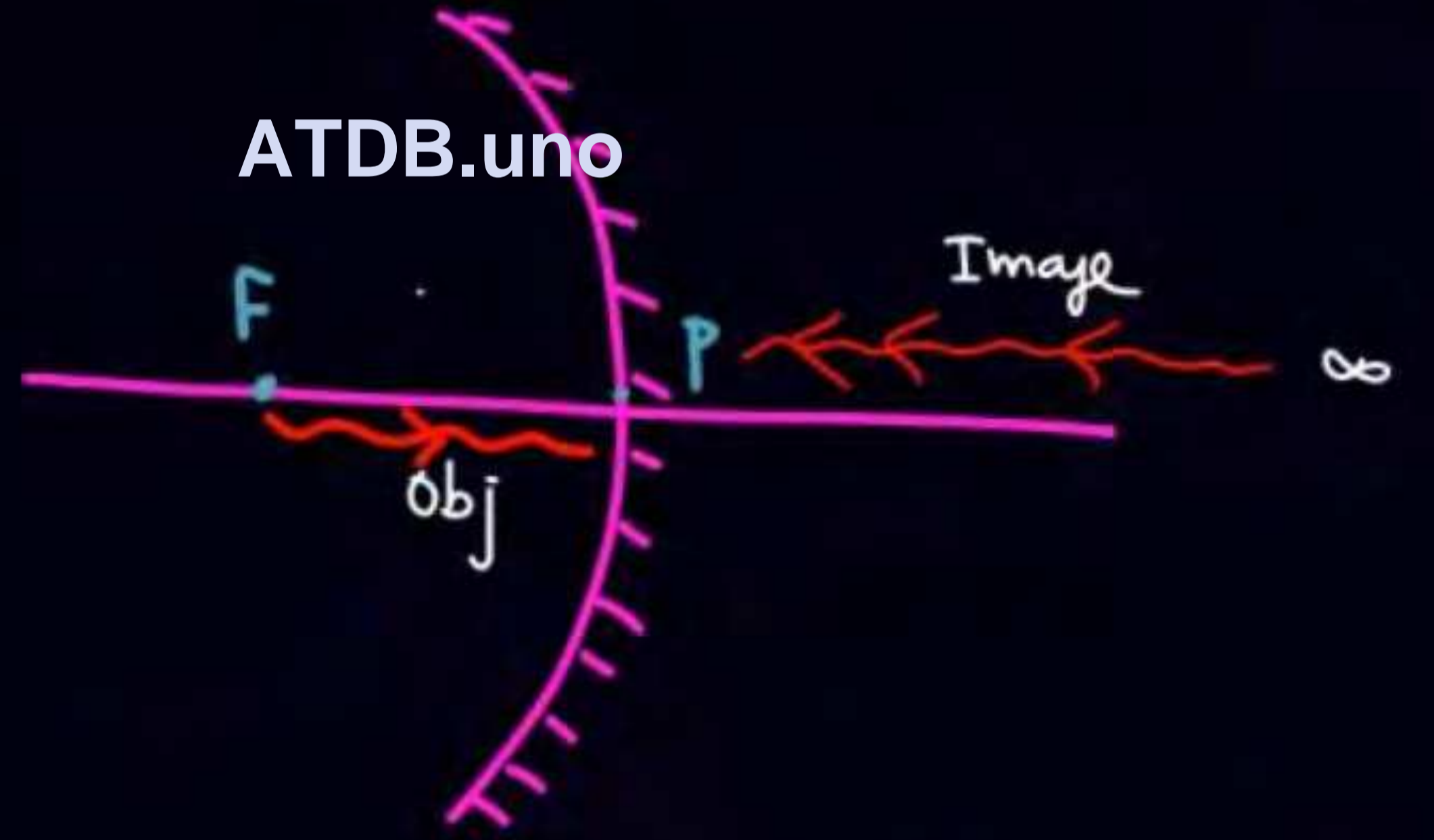
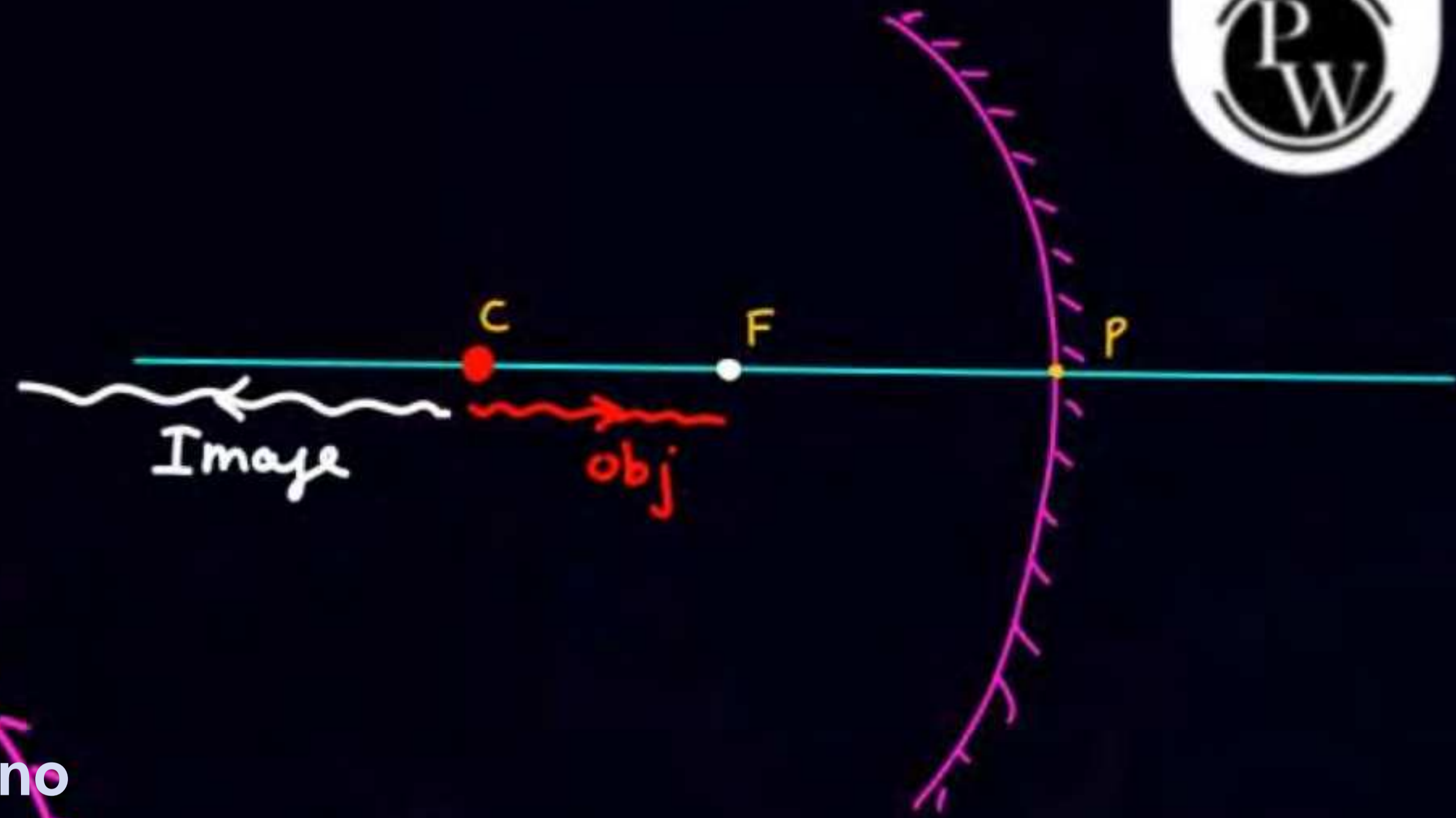
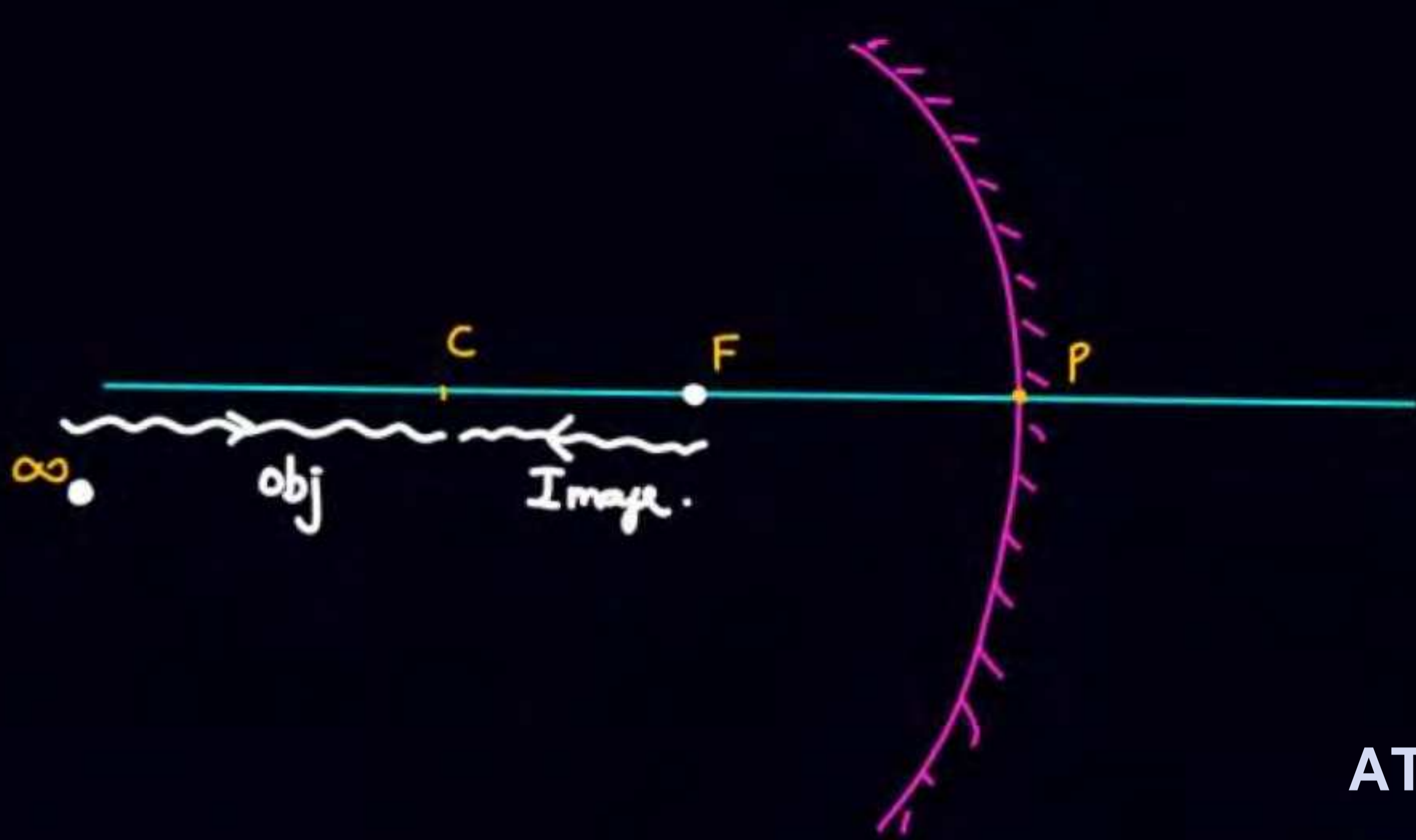

ATDB.uno





Image Formation by Spherical Mirrors



Concave mirror:

(i) **Object** : Placed at infinity

Image : real, inverted, diminished at F

$$|m| \ll 1 \quad \text{and} \quad m < 0$$

ATDB.uno

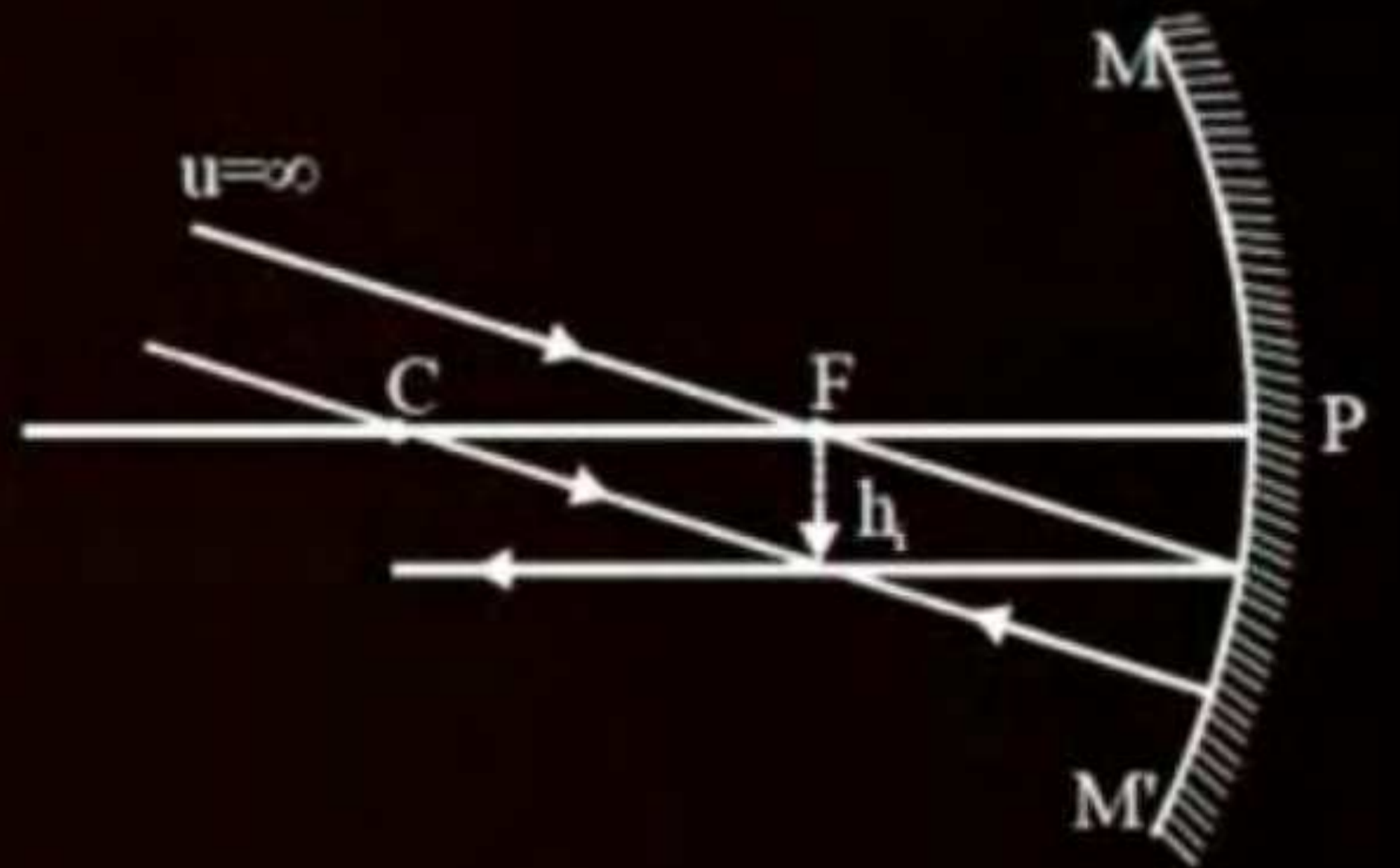

(ii) **Object** : Placed in between infinity and C

Image : real, inverted, diminished in between C and F

$$|m| \ll 1 \quad \text{and} \quad m < 0$$

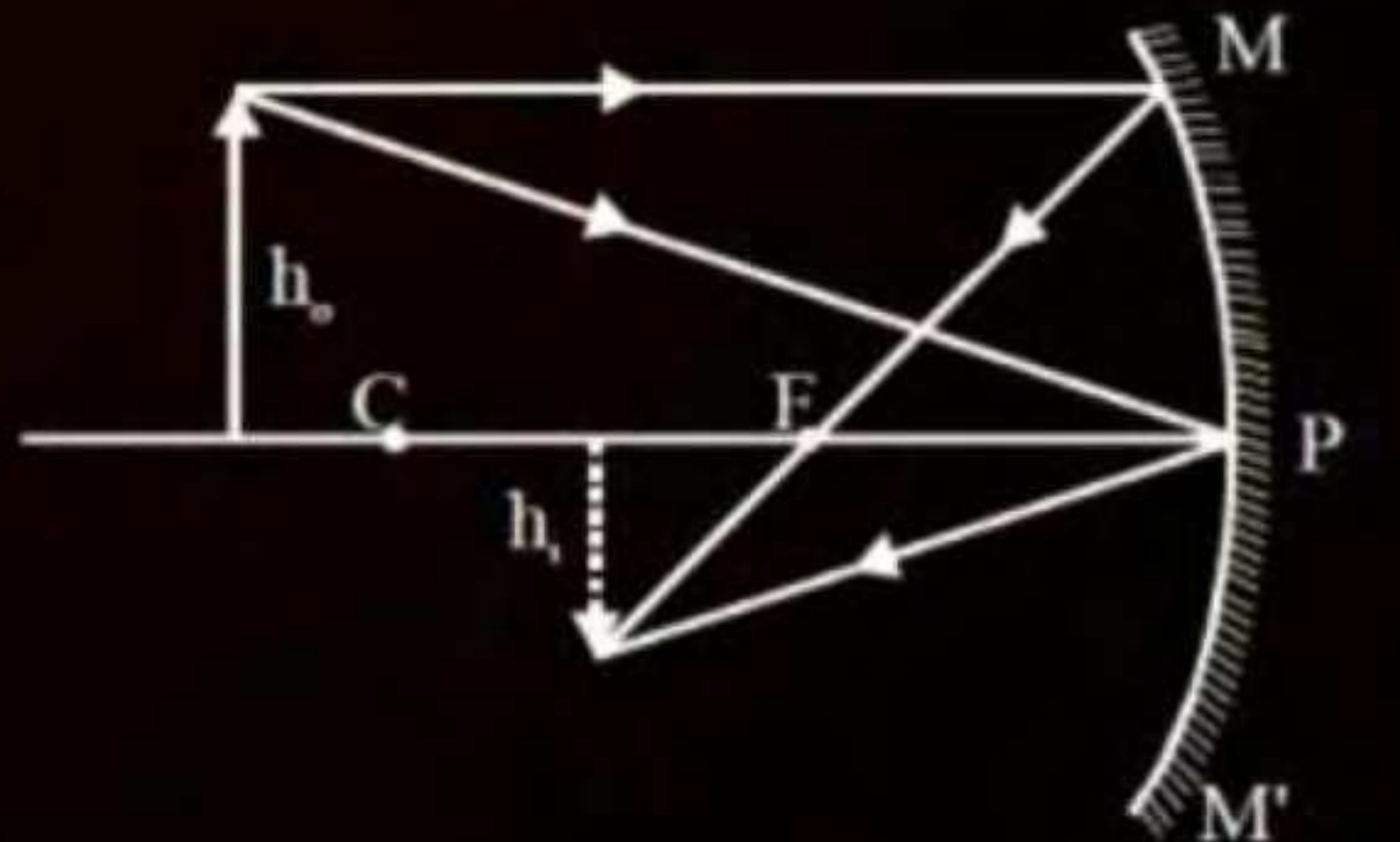



(iii) **Object** : Placed at C

Image : real, inverted, equal at F

$$(m = -1)$$

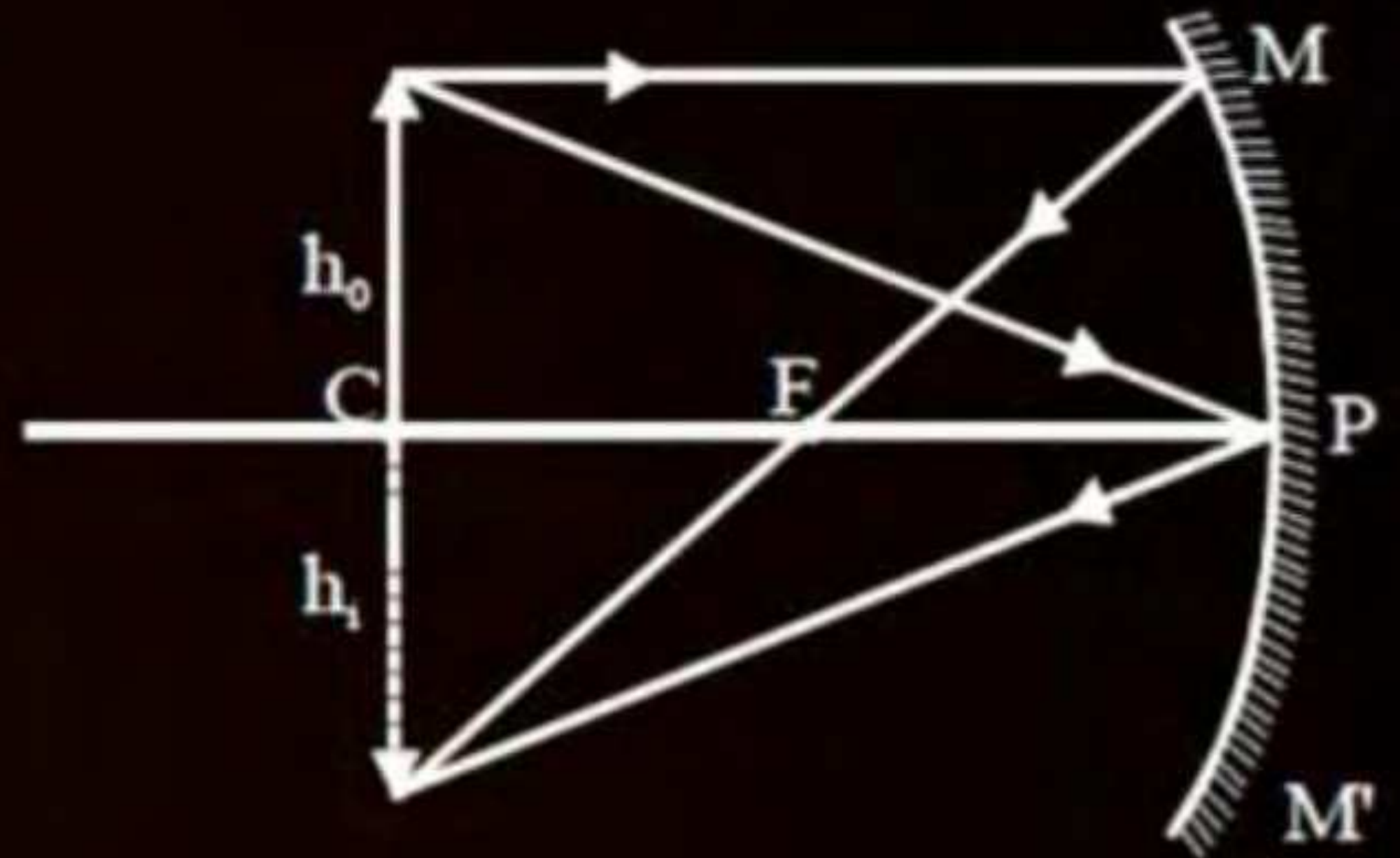

ATDB.uno

(iv) **Object** : Placed in between F and C

Image : real, inverted, enlarged beyond C

$$|m| > 1 \text{ and } m < 0$$

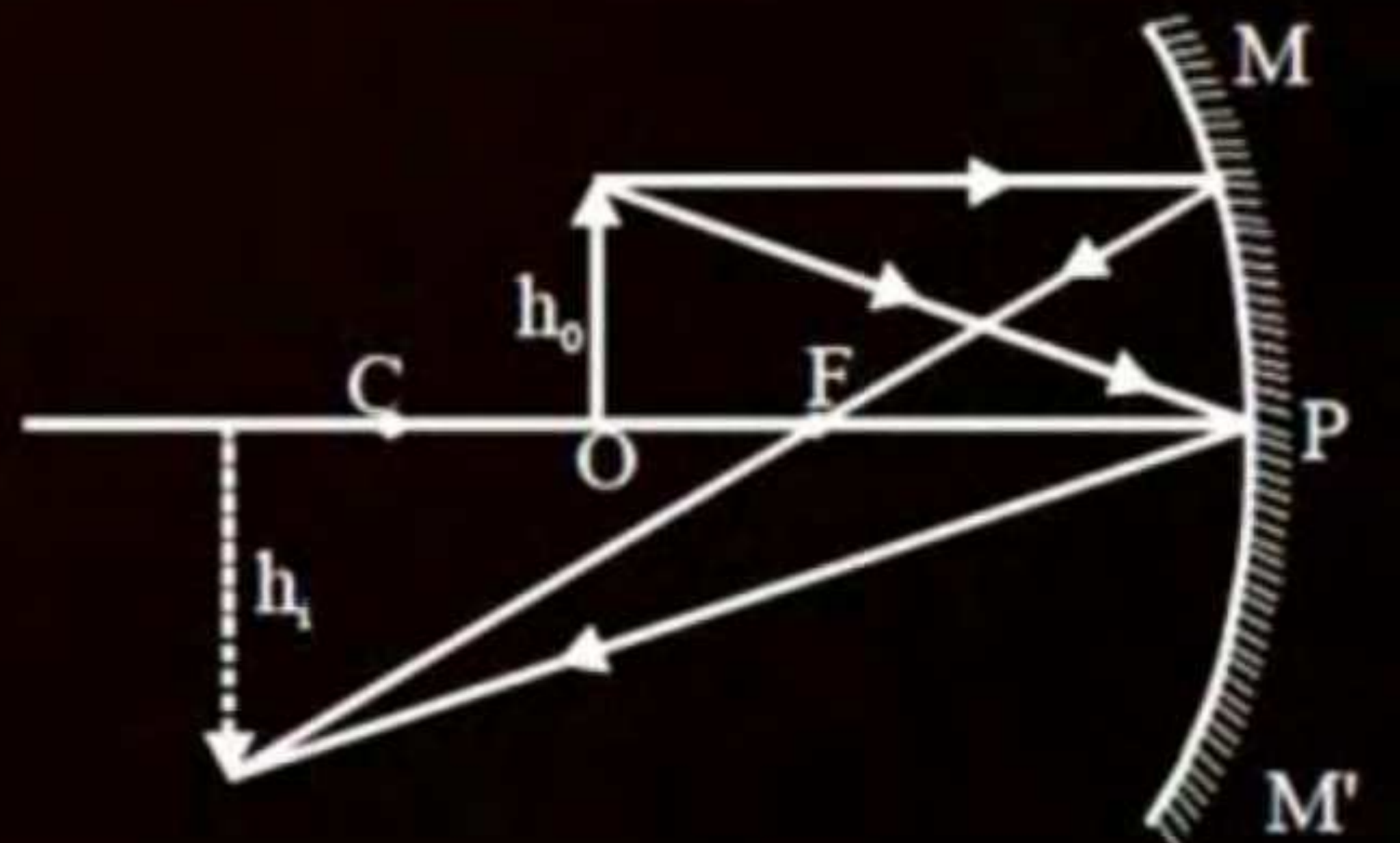



(v) **Object** : Placed at F

Image : real, inverted, very large (assumed at infinity)

$$(m \ll -1)$$

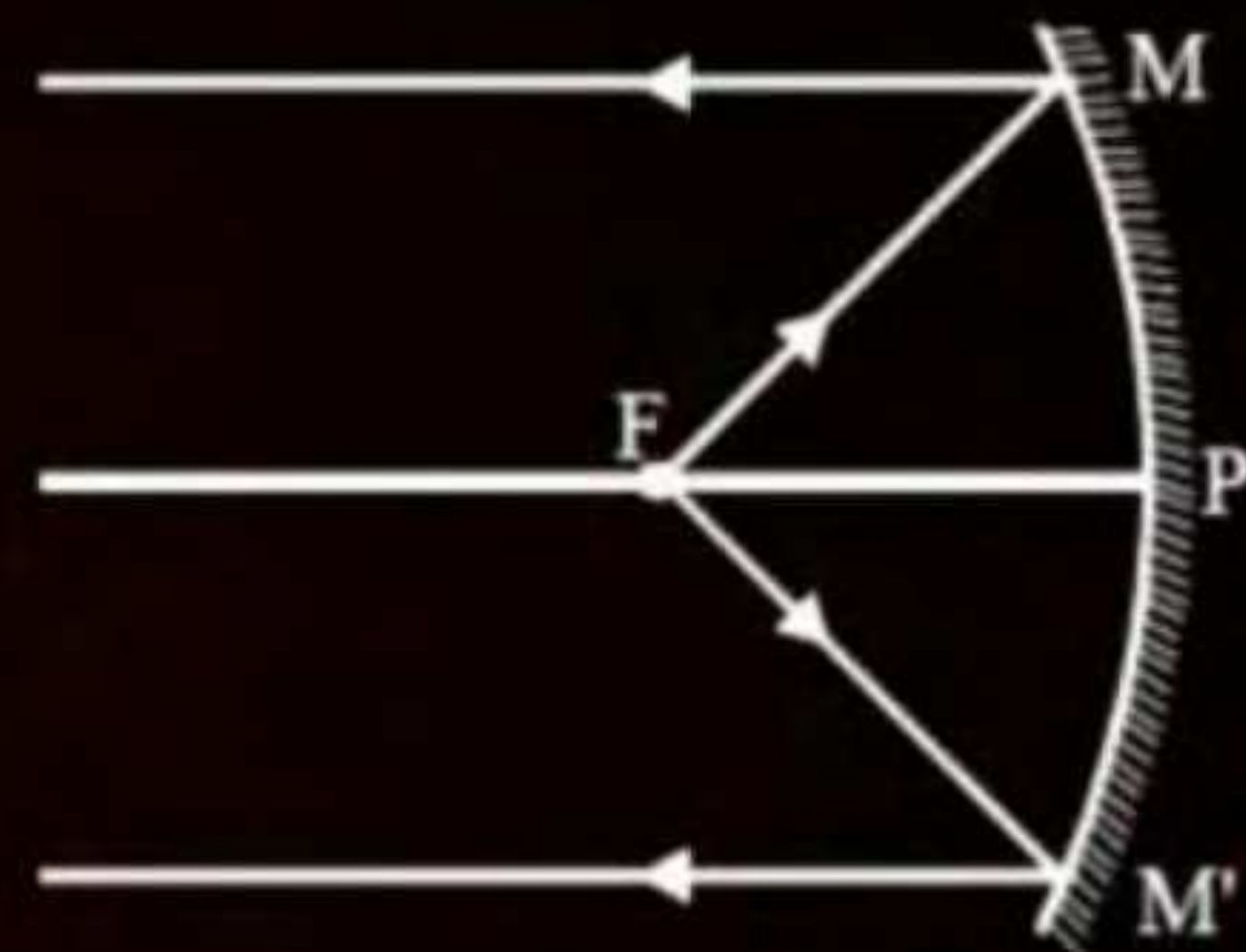

ATDB.uno

(vi) **Object** : Placed in between F and P

Image : virtual, erect, enlarged and behind the mirror ($m > +1$)

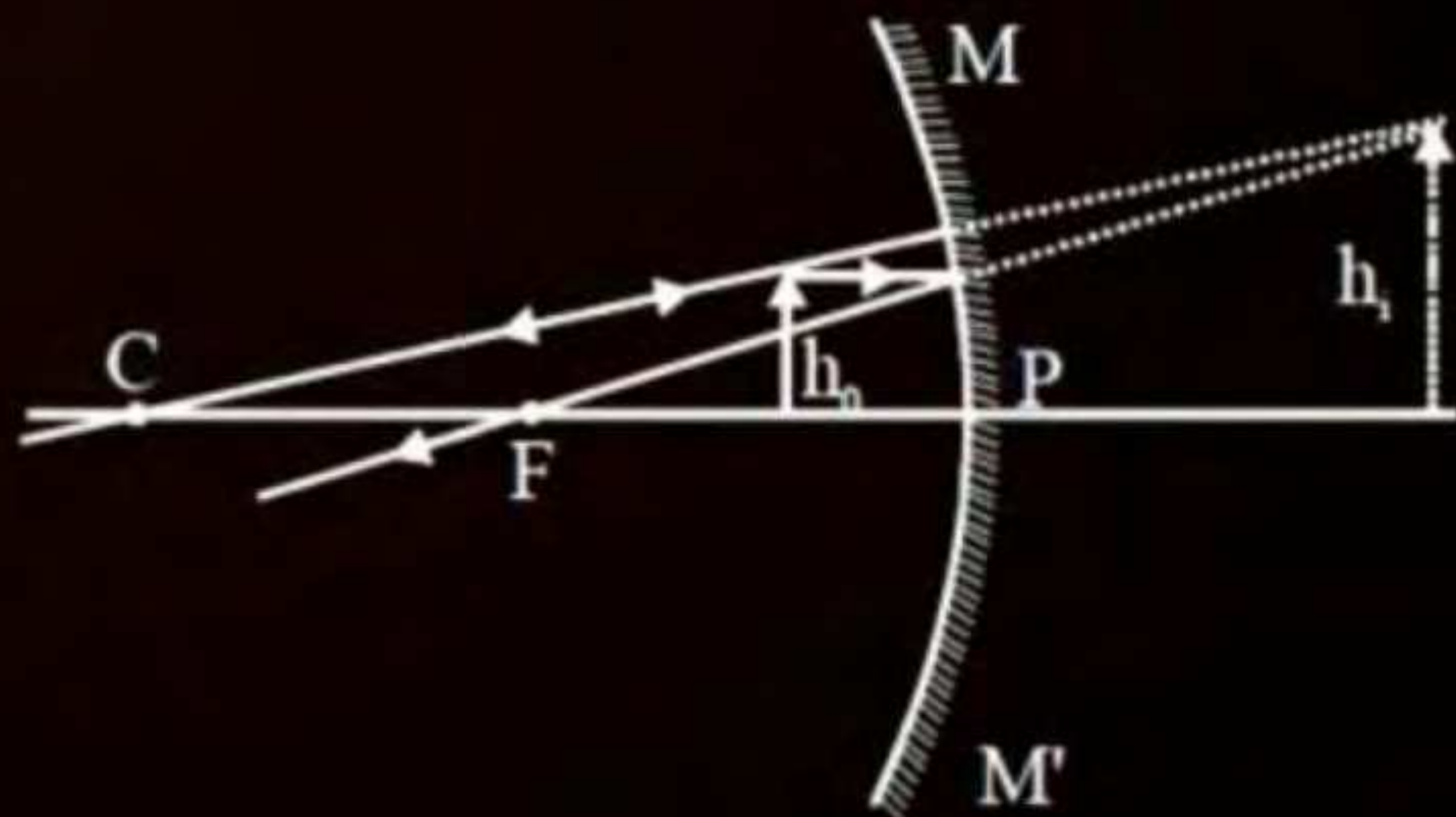



FOR CONCAVE MIRROR

Object	Image	Magnification
$-\infty$	F	$ m \ll 1$ & $m < 0$
$-\infty - C$	C - F	$ m < 1$ & $m < 0$
C	C	$m = -1$
C - F	$-\infty - C$	$ m > 1$ & $m < 0$
Just before F towards C	$-\infty$	$m \ll -1$
Just after F towards P	$+\infty$	$m \gg 1$

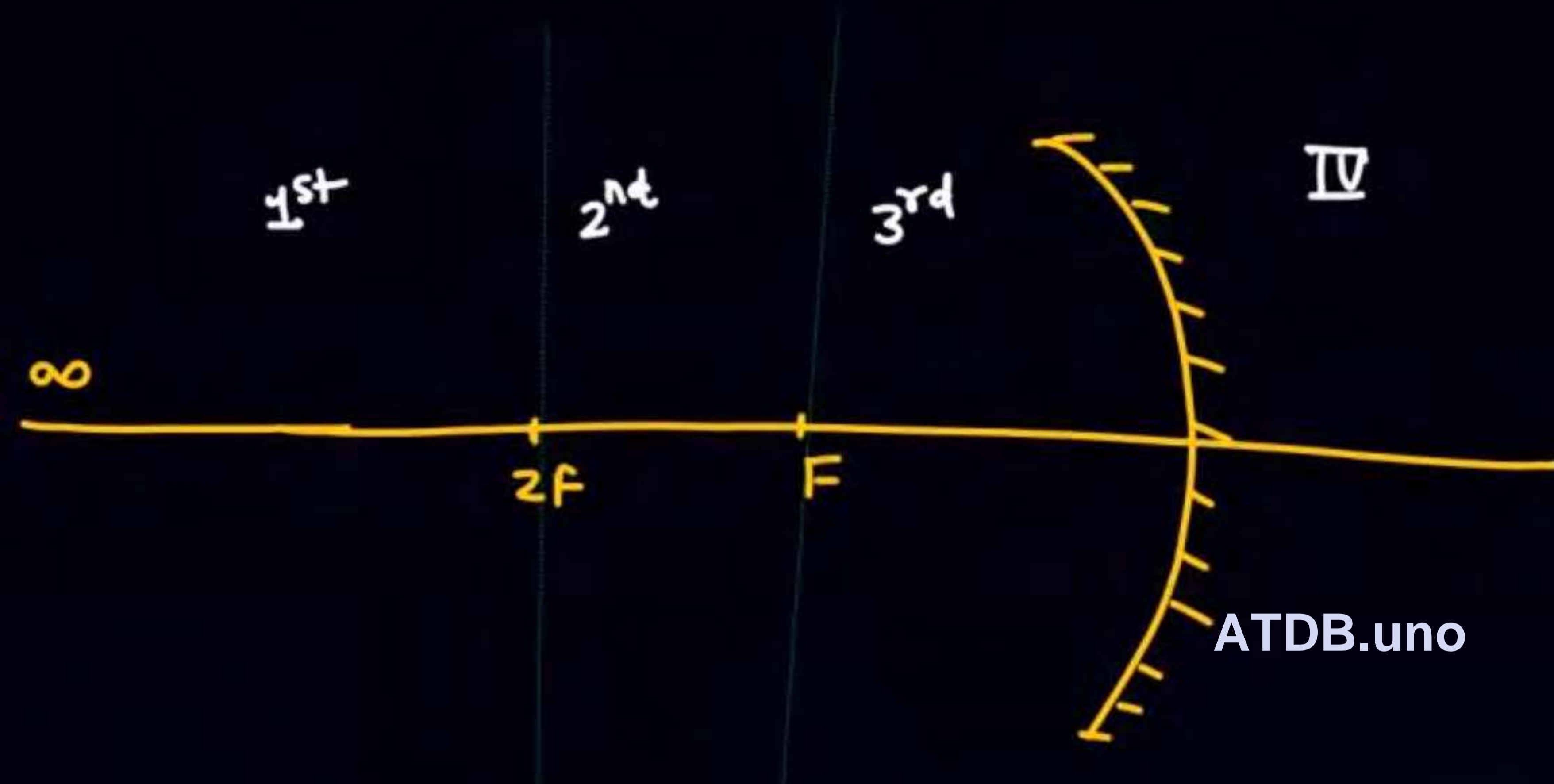

obj	Image	
1	2	Real, inverted, small
2	1	Real, inverted or or
3	4	Virtual, erect or or
4	3	Real, inverted small



#

If obj is very small

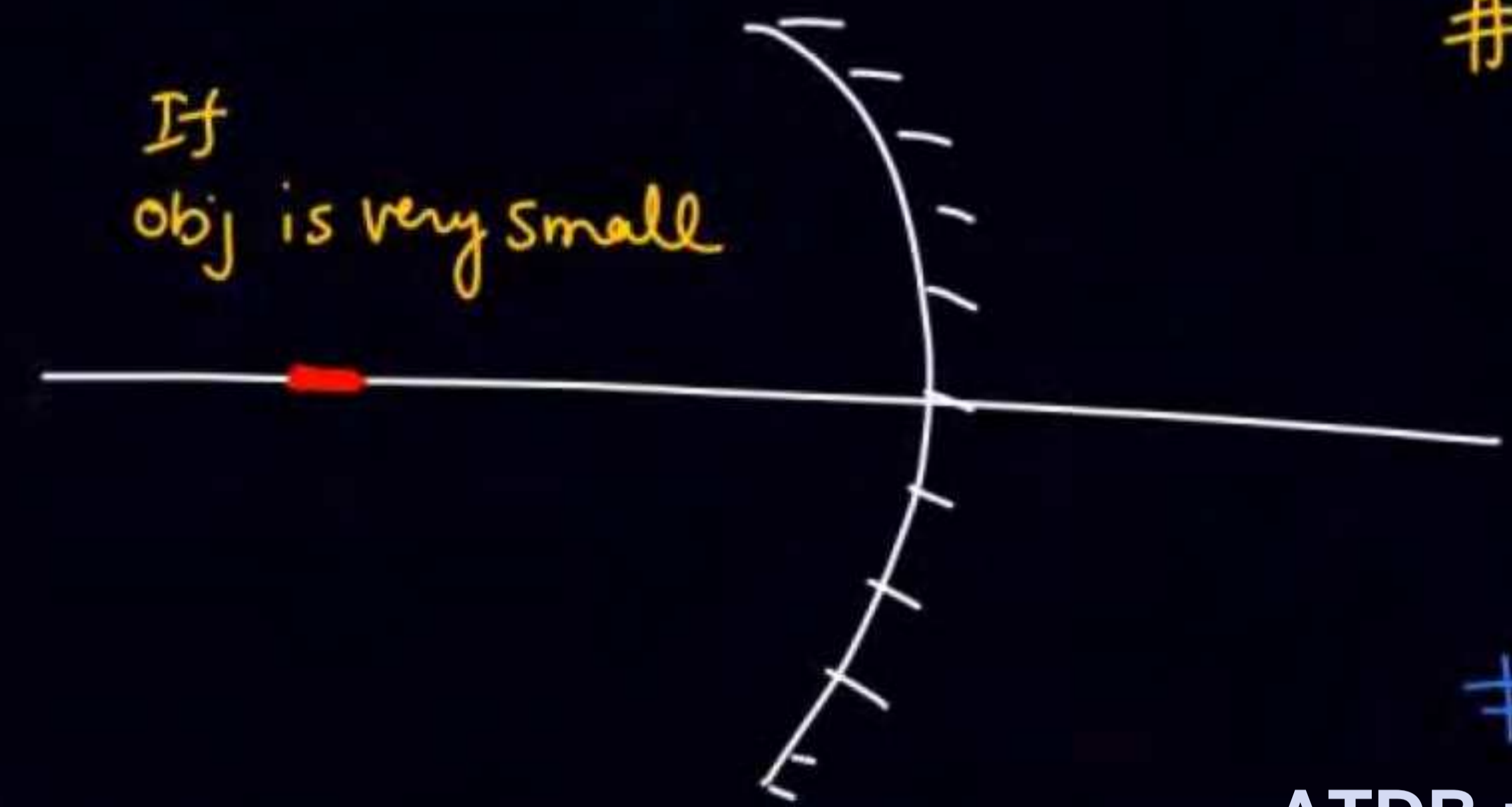

#

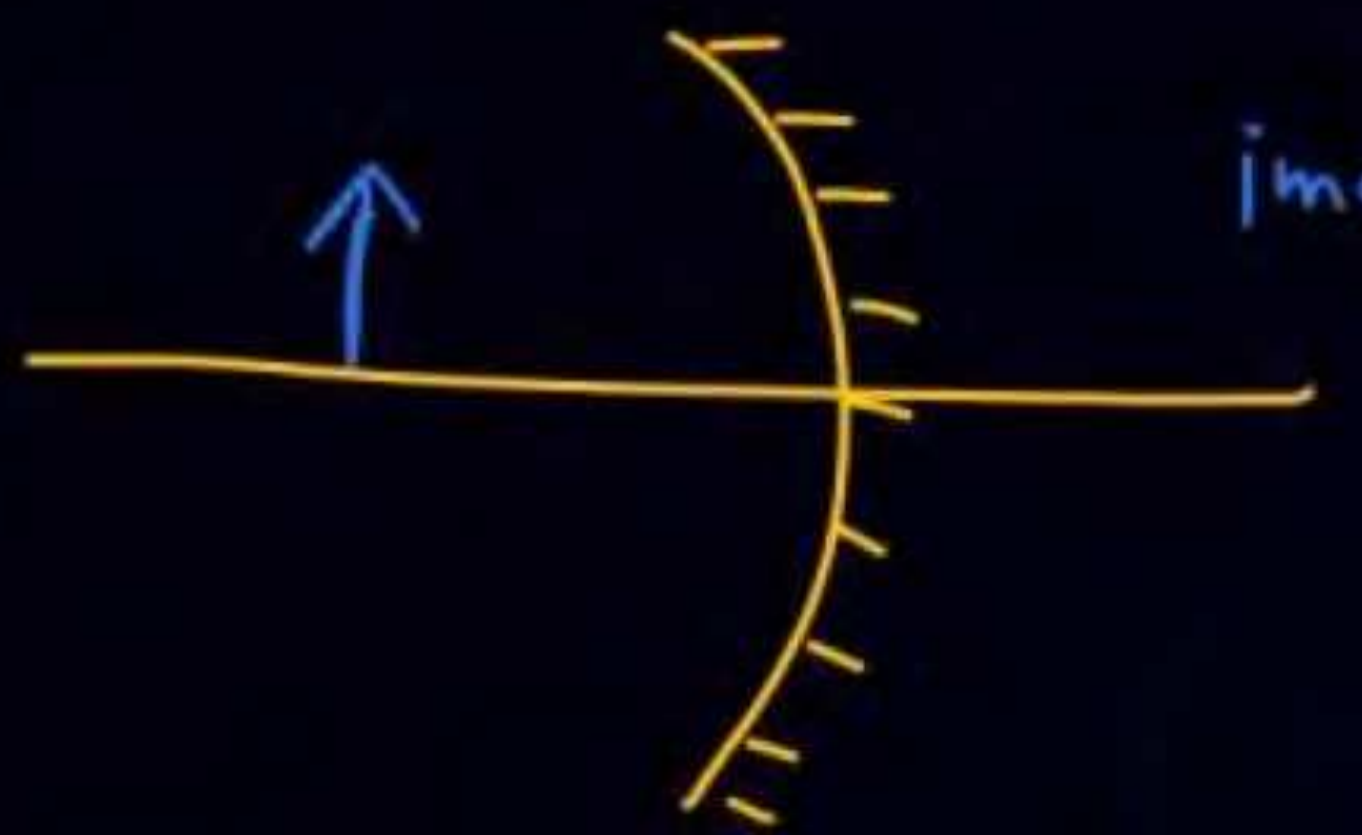
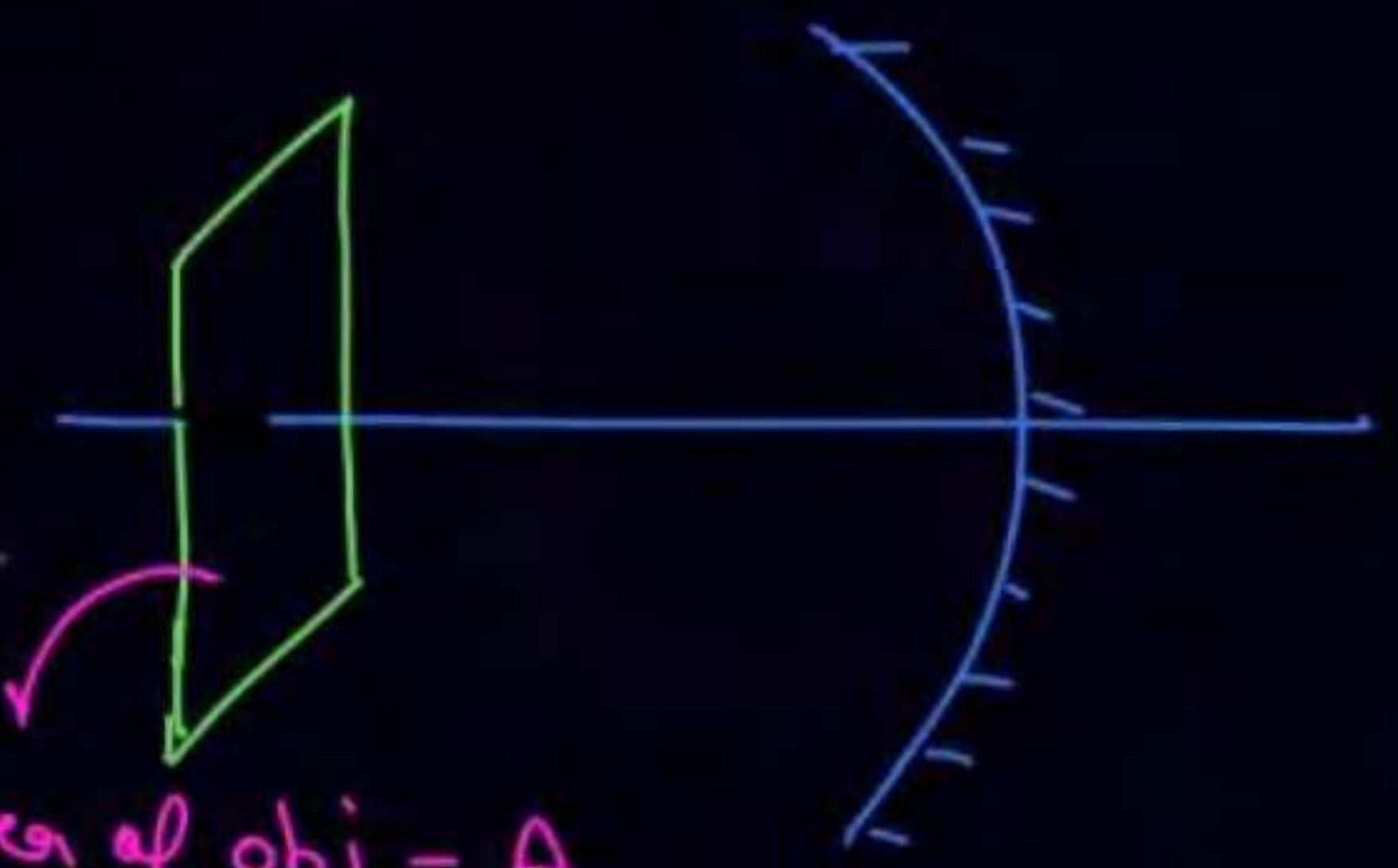

image की length में दिना एत वता है

ATDB.uno

#



Length of image = m^2 (Length of obj)

Area of obj = A_0

Area of image = $m^2 A_0$



very small cube l

Volⁿ of obj = V_0

Vol of image = $(m \times m \times m^2) (\text{Vol})_{\text{obj}}$

$= m^4 (\text{Vol}^n)_{\text{obj}}$ *mb'*

Q

$l = 1 \text{ mm}$

$f = 20 \text{ cm}$

30 cm

Vol of image of cube = $m^4 (\text{Vol}^n \text{ of obj})$

$= 2^4 \times (1 \text{ mm})^3$

$= 16 \text{ mm}^3$

Concave mirror

- (i) **Object** : Placed at infinity
Image : real, inverted, diminished at F
 $|m| \ll 1$ & $m < 0$

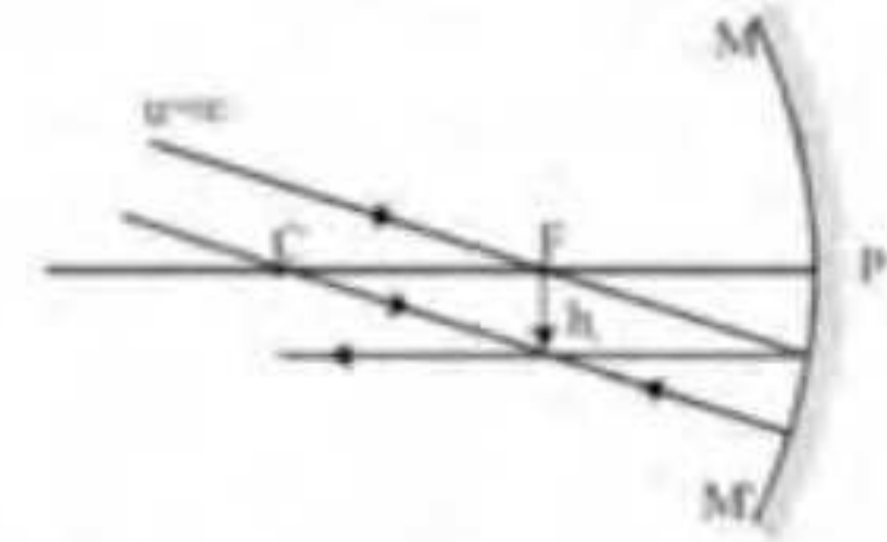

- (ii) **Object** : Placed in between infinity and C
Image : real, inverted, diminished in between C and F
 $|m| < 1$ & $m < 0$

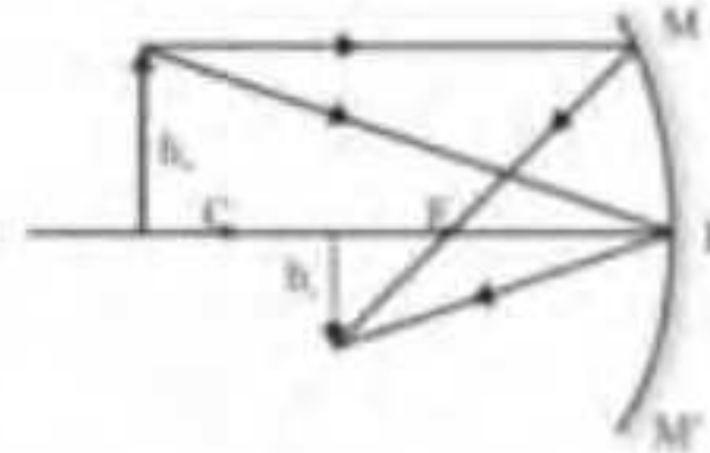

- (iii) **Object** : Placed at C
Image : real, inverted, equal at C
 $(m = -1)$

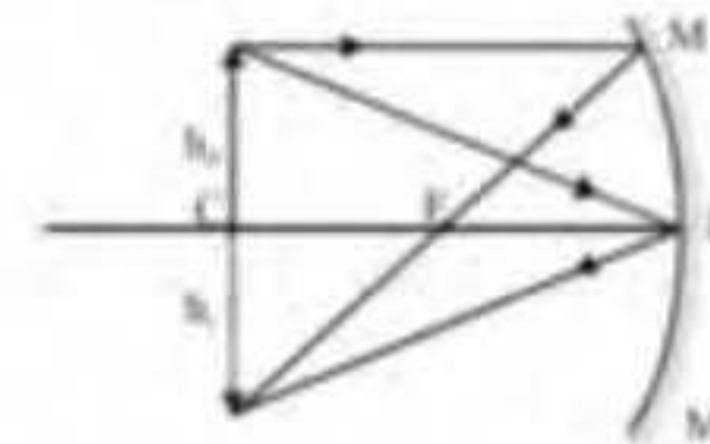

- (iv) **Object** : Placed in between F and C
Image : real, inverted, enlarged beyond C
 $|m| > 1$ & $m < 0$

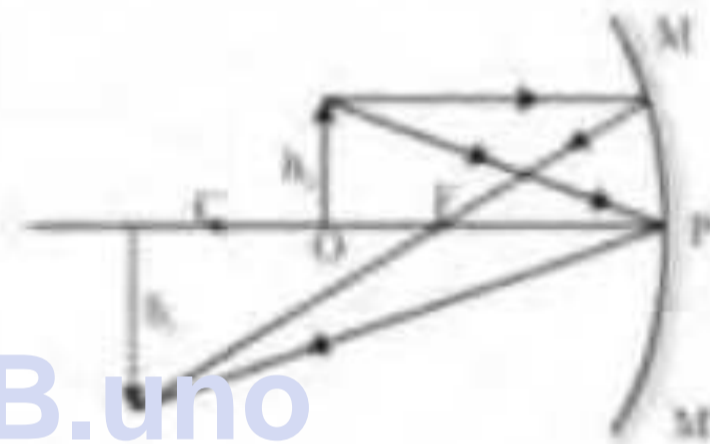

- (v) **Object** : Placed at F
Image : real, inverted, very large (assumed) at infinity ($m \ll -1$)

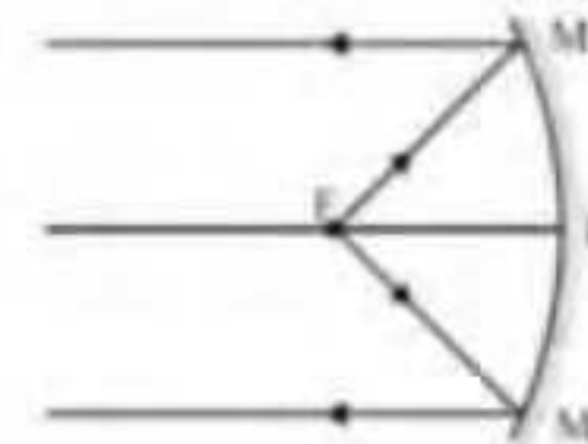

- (vi) **Object** : Placed between F and P
Image : virtual, erect, enlarged and behind the mirror ($m > +1$)

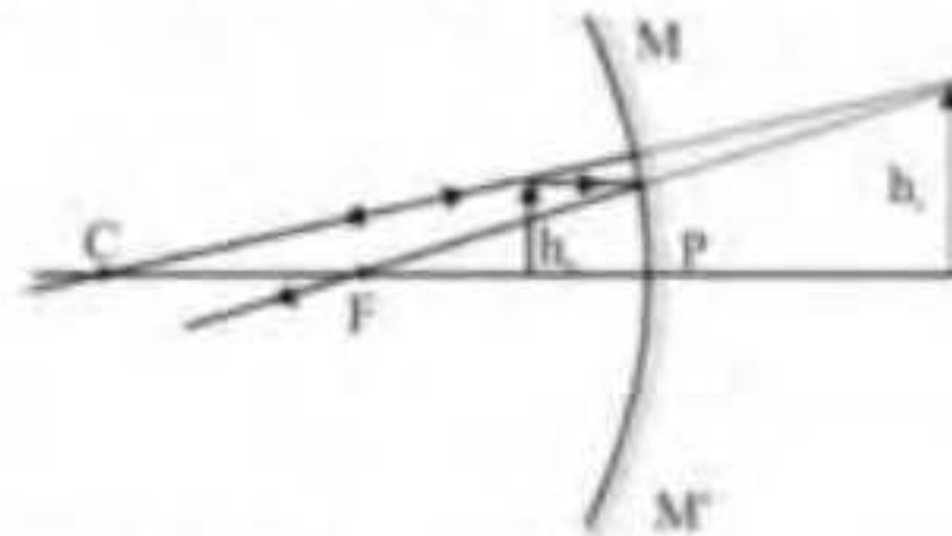

ATDB.uno

For concave mirror

Object	Image	Magnification
$-\infty$	F	$ m \ll 1$ & $m < 0$
$-\infty - C$	C - F	$ m < 1$ & $m < 0$
C	C	$m = -1$
C - F	$-\infty - C$	$ m > 1$ & $m < 0$
Just before F towards C	$-\infty$	$m \ll -1$

Superficial magnification

If two dimensional object placed with its plane perpendicular to principal axis its magnification is known as superficial magnification

$$\text{Linear magnification } m = \frac{h_i}{h_o} = \frac{w_i}{w_o}$$

$$h_i = mh_o, w_i = mw_o \text{ and } A_{\text{obj}} = h_o \times w_o$$

$$\text{Area of image : } A_{\text{image}} = h_i \times w_i = mh_o \times mw_o = m^2 A_{\text{obj}}$$

$$\text{superficial magnification } m_s = \frac{\text{area of image}}{\text{area of object}} = \frac{(ma) \times (mb)}{(a \times b)} = m^2$$

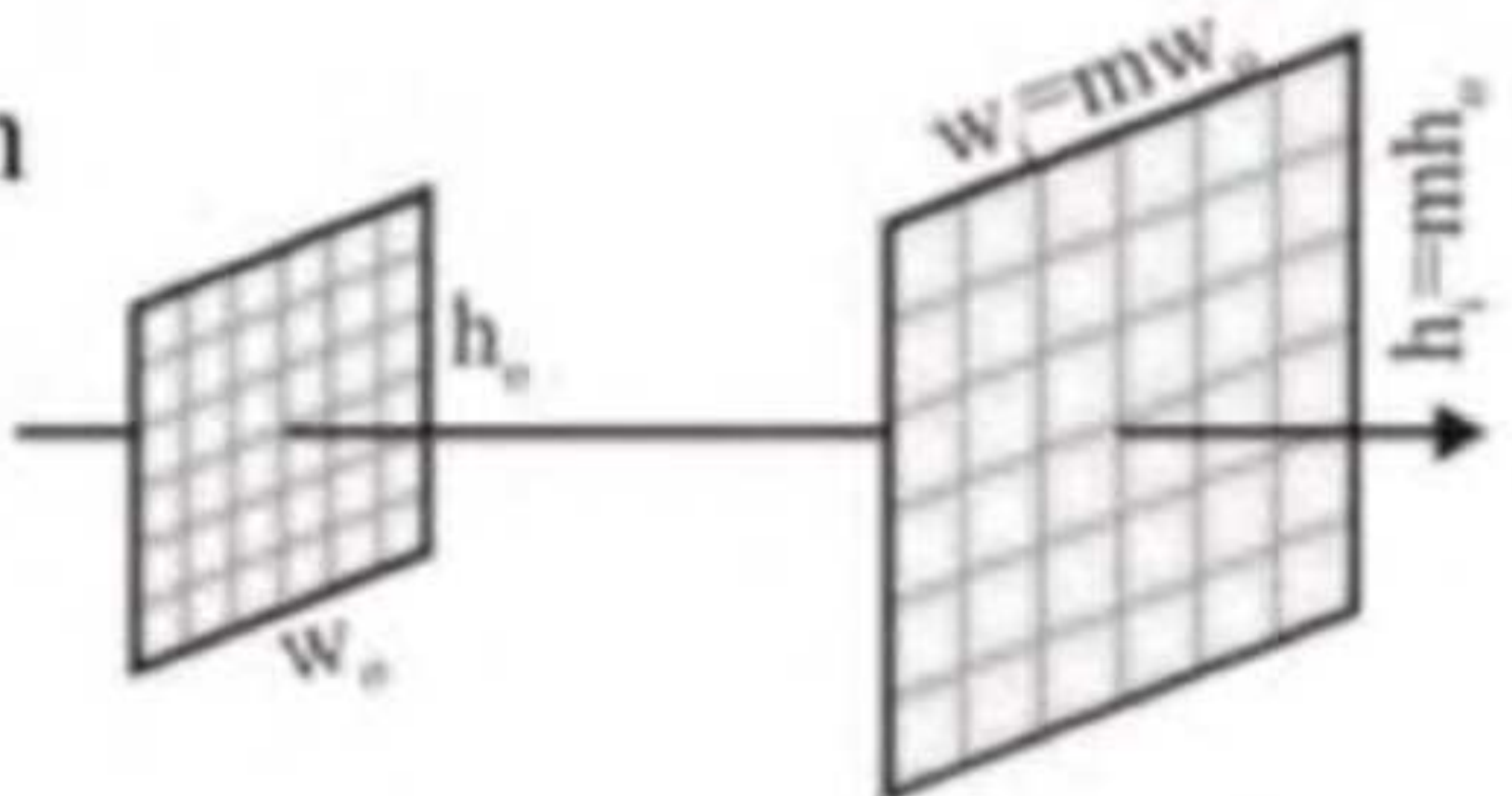

If one dimensional object is placed perpendicular to the principal axis then linear magnification is

called transverse or lateral magnification.

$$m = \frac{h_i}{h_o} = -\frac{v}{u}$$

Magnification

$$|m| > 1$$

$$m < 0$$

Image

enlarged

inverted

Magnification

$$|m| < 1$$

$$m > 0$$

Image

diminished

erect

- **Longitudinal magnification**

If one dimensional object is placed with its length along the principal axis then linear magnification is called longitudinal magnification.

Longitudinal magnification $m_L = \frac{\text{length of image}}{\text{length of object}} = \frac{|v_2 - v_1|}{|u_2 - u_1|}$

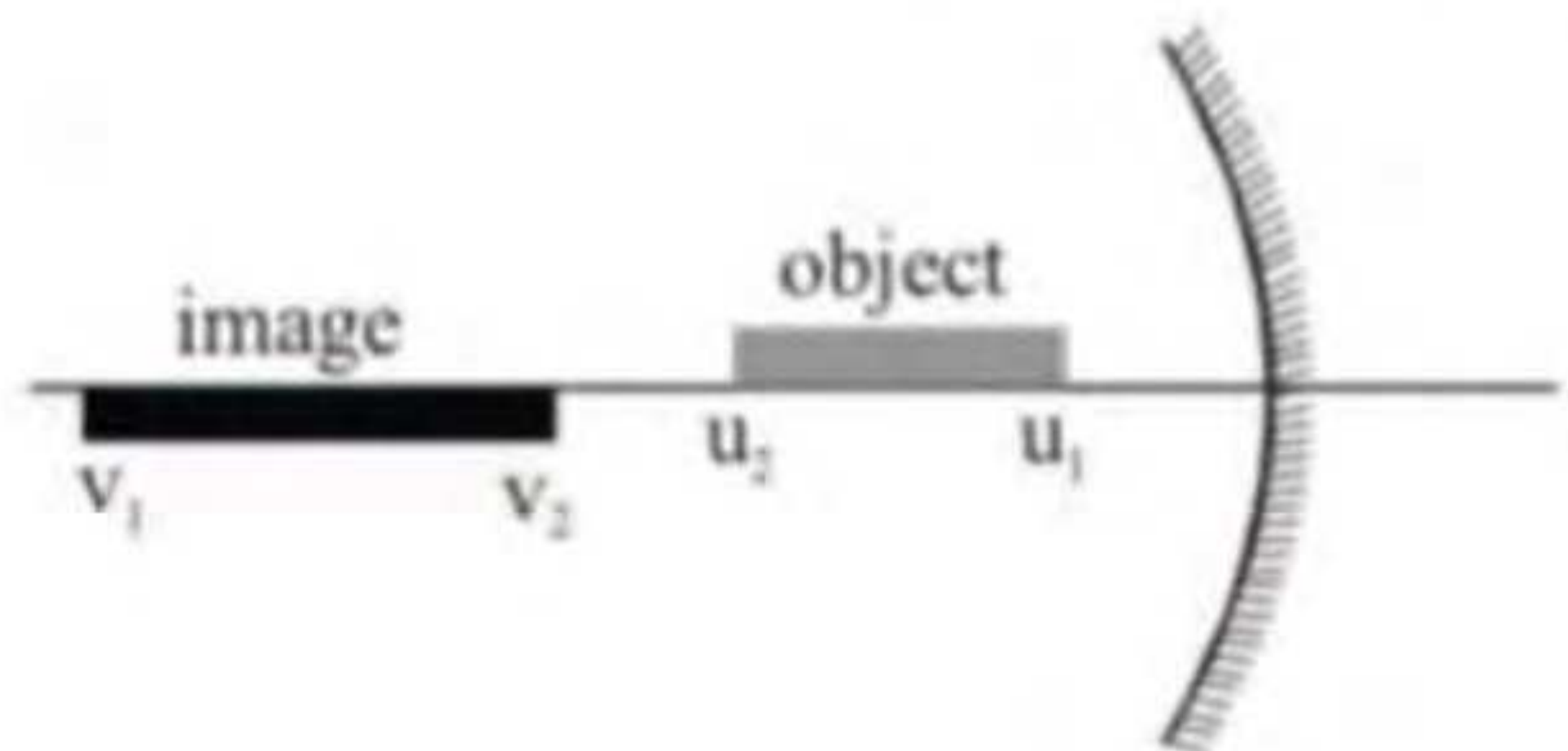

For small objects only : $m_L = -\frac{dv}{du}$

differentiation of $\frac{1}{v} + \frac{1}{u} = \frac{1}{f}$ gives us $-\frac{dv}{v^2} - \frac{du}{u^2} = 0 \Rightarrow -\frac{dv}{du} = \left[\frac{v}{u}\right]^2$ so $m_L = -\frac{dv}{du} = \left[\frac{v}{u}\right]^2 = m^2$

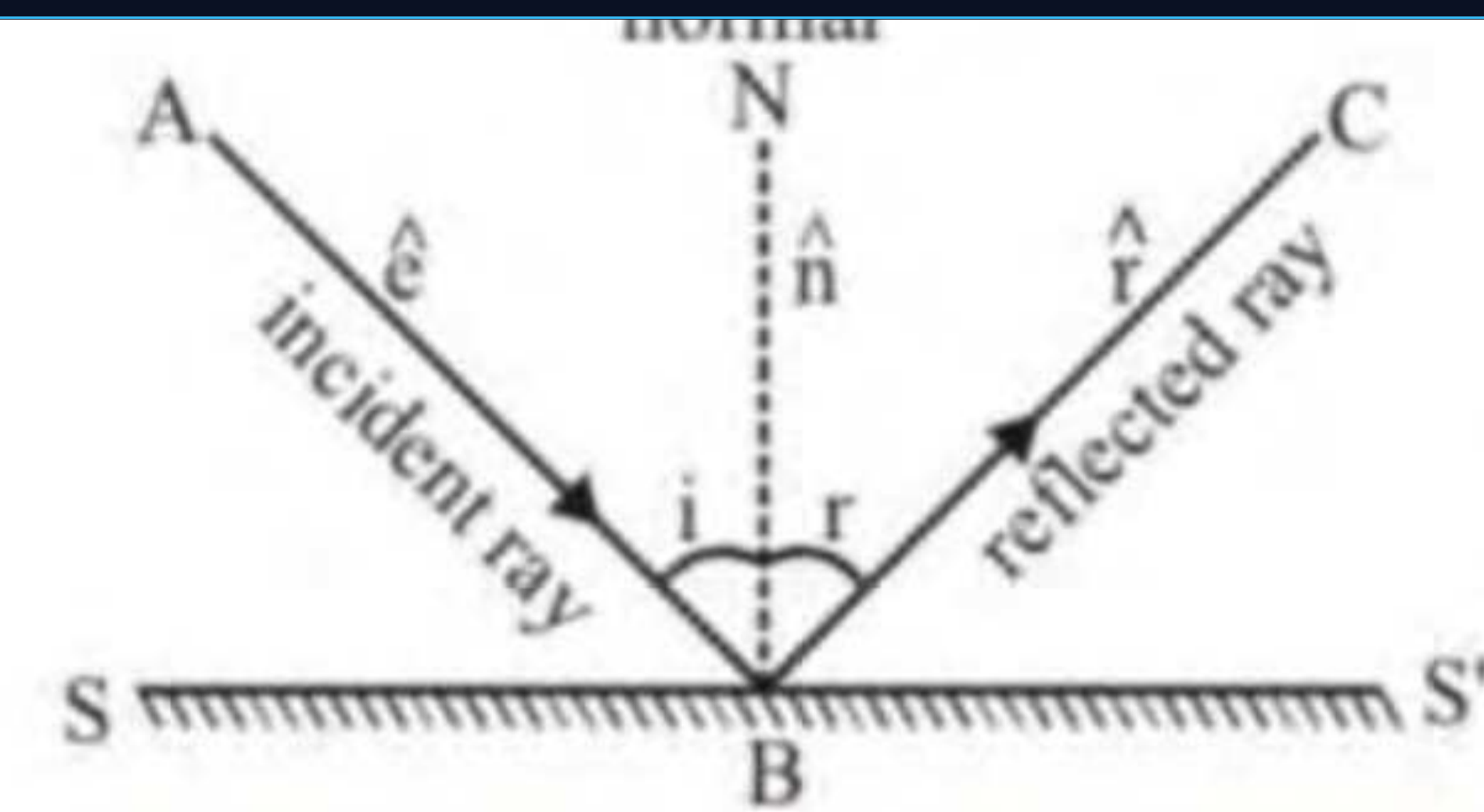

In vector form $\boxed{\hat{r} = \hat{e} - 2(\hat{e} \cdot \hat{n})\hat{n}}$

ATDB.uno



THANK YOU

ATDB.uno

