

PRAYAS

JEE 2025



ATDB.uno

Lecture - 11 Physics

Laws Of Motion



By- Saleem Ahmed Sir



Topics *to be covered*

1

Friction Ques practice

ATDB.uno

2

3

4



h.w
JA 9

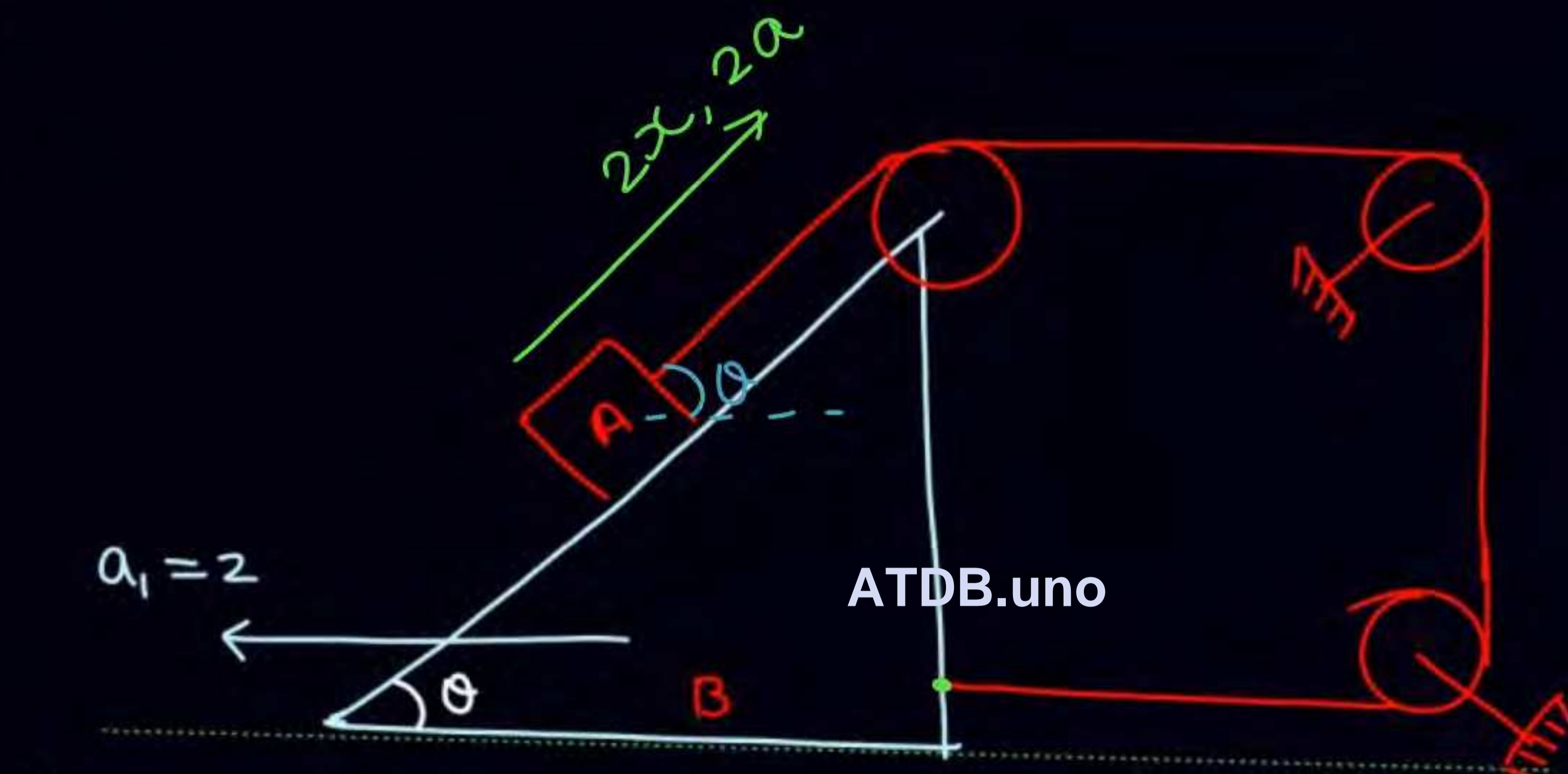

acc of A wrt ground
is vertically upward
find $\theta, a_A, a_{A/B}$

$$\vec{a}_{A/B} = 4 \cos \theta \hat{i} + 4 \sin \theta \hat{j}$$

$$\vec{a}_A - \vec{a}_B = (\quad) \hat{i} + (\quad) \hat{j}$$

$$\vec{a}_A - (-2 \hat{i}) = (\quad) \hat{i} + (\quad) \hat{j}$$

$$\vec{a}_A = (4 \cos \theta - 2) \hat{i} + (4 \sin \theta) \hat{j}$$

$$4 \cos \theta - 2 = 0$$

$$\theta = 60$$

$$a_i = 2$$

$$x, a$$

$$\vec{a}_A = 0 \hat{i} + 4 \sin 60 \hat{j}$$

$$\vec{a}_A = 2\sqrt{3} \hat{j}$$

$$\vec{a}_{A/B} = 4$$

ATDB.uno



①
Q

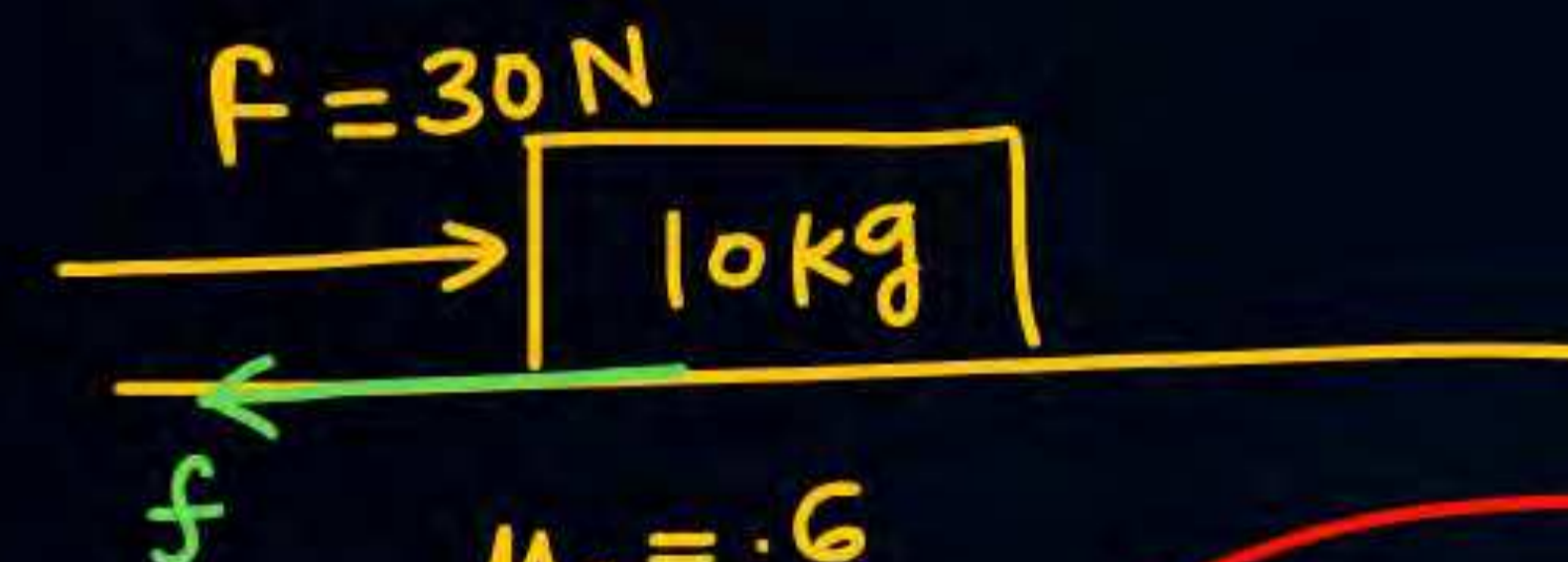

$$\mu_s = .6$$

$$\mu_k = .4$$

$$f_k = .4 \times 100 = 40$$

$$(f_s)_{\max} = .6 \times 100 = 60$$

$$a = 0, f_s = 30$$

$$f_k = \mu_k N$$

②

Q

If $F = 70 \text{ N}$ (in last ques)

$$a = \frac{70 - 40}{10} \quad \text{move}$$

ATDB.uno

$$a = 3$$

$$f = 40 \text{ (kinetic)}$$

3

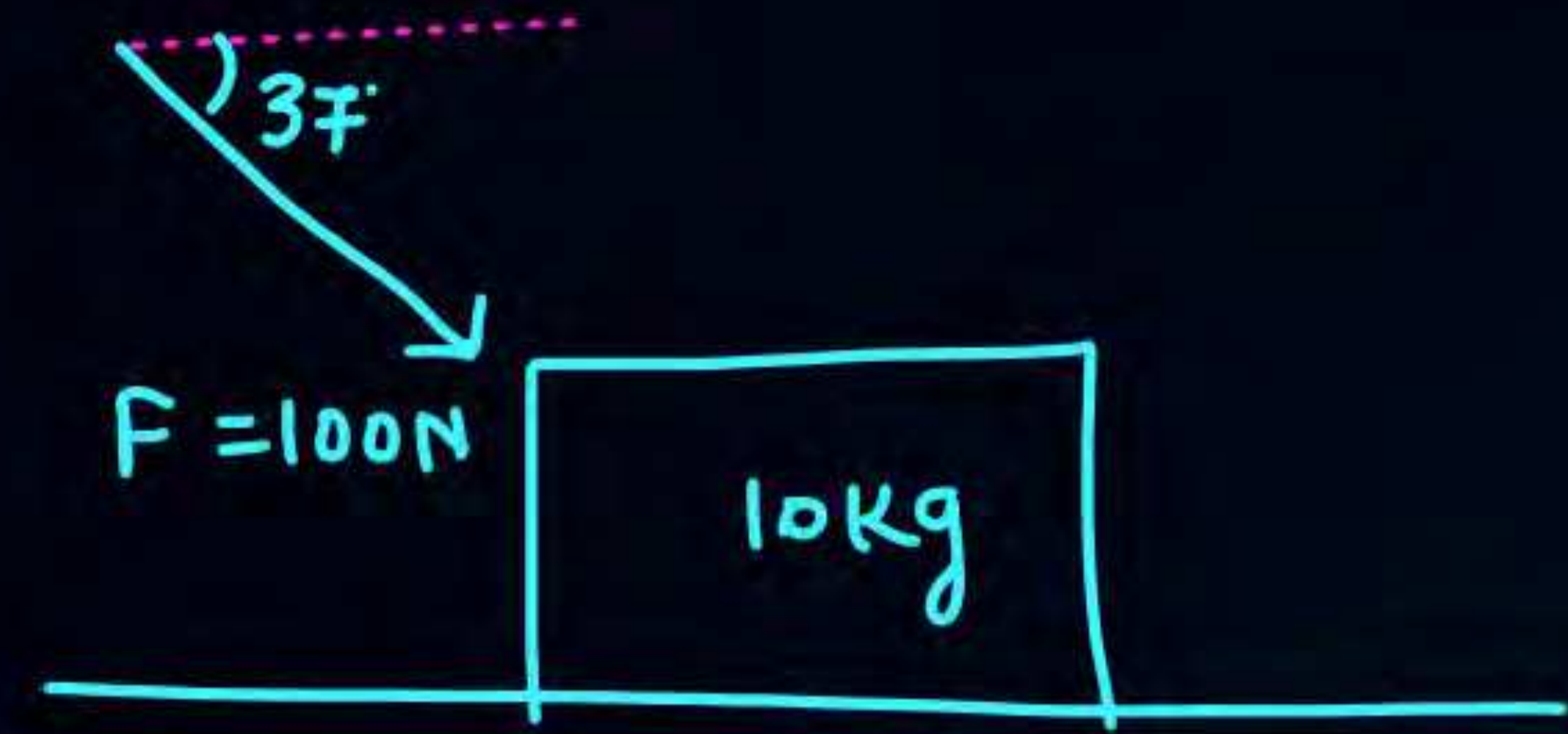

$\mu_s = .6$
 $\mu_k = .4$

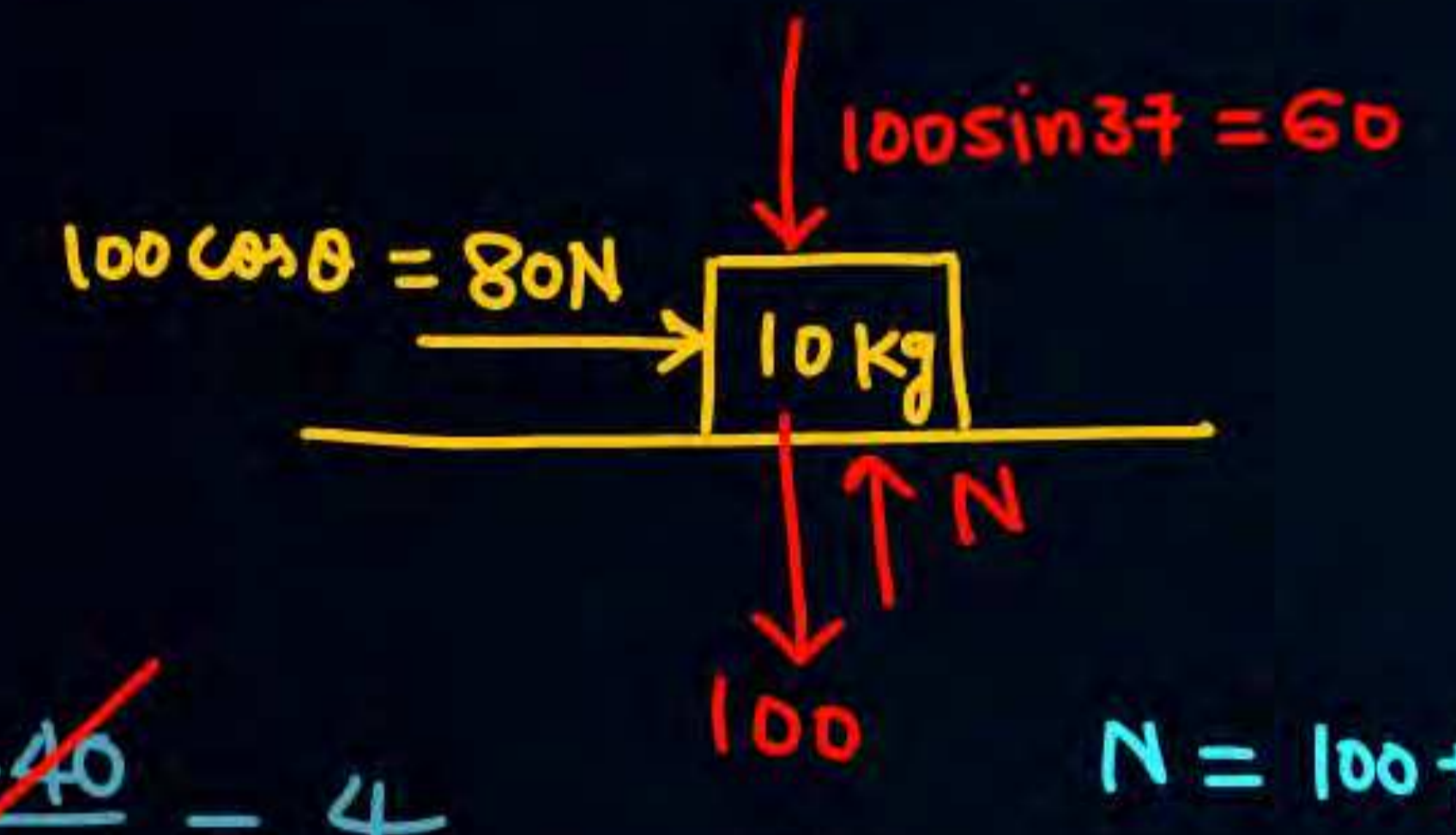

ATDB.uno

~~$a = \frac{80 - 40}{10} = 4$~~

$N = 100 + 60 = 160$

$(f_s)_{max} = \mu_s N = .6 \times 160 = 96$

$a = 0$, $f_s = 80$

4

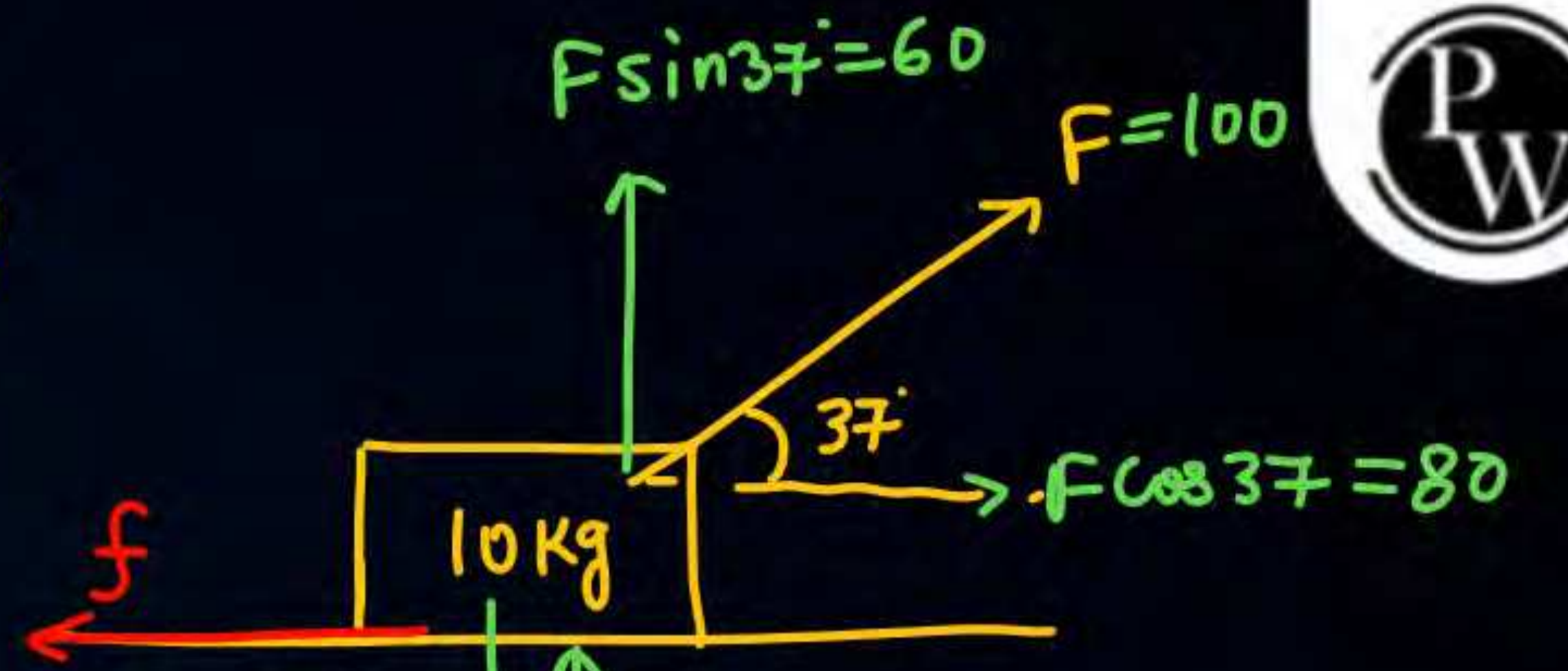

$\mu_s = .6$
 $\mu_k = .4$

$N = 40$
 $(f_s)_{max} = \mu_s N = .6 \times 40 = 24$

$f_k = .4 \times 40 = 16$

$a = \frac{80 - 16}{10} = 6.4$

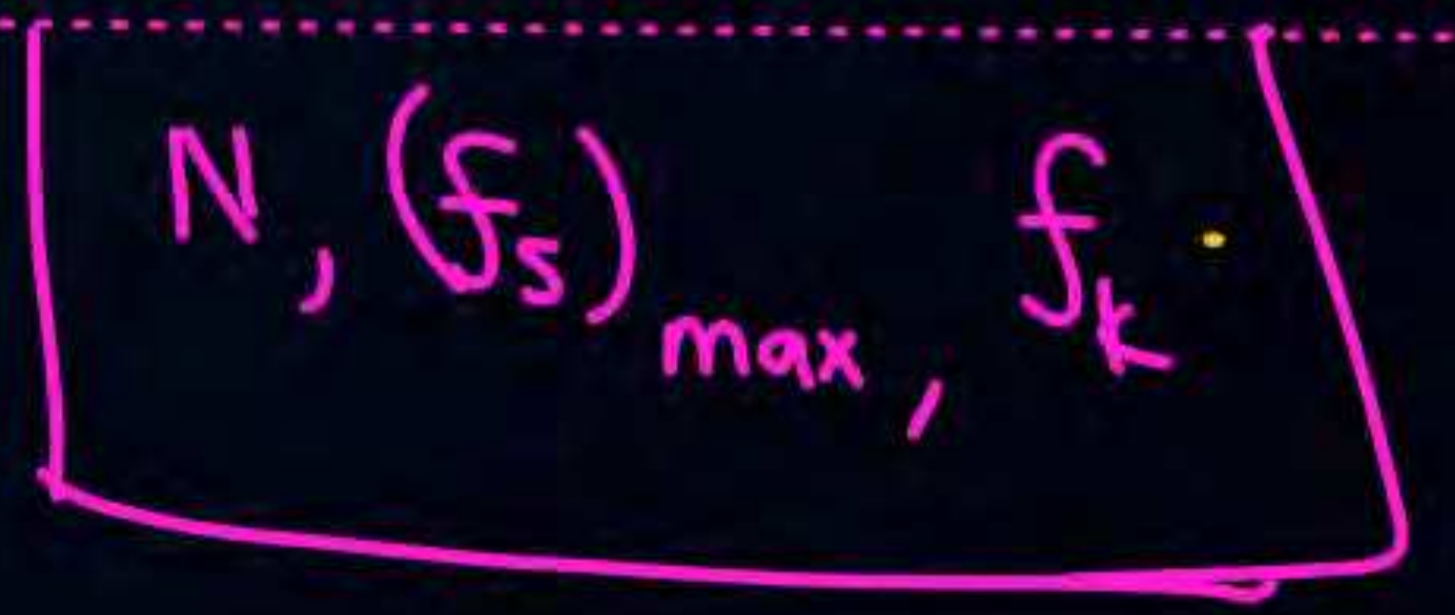



5

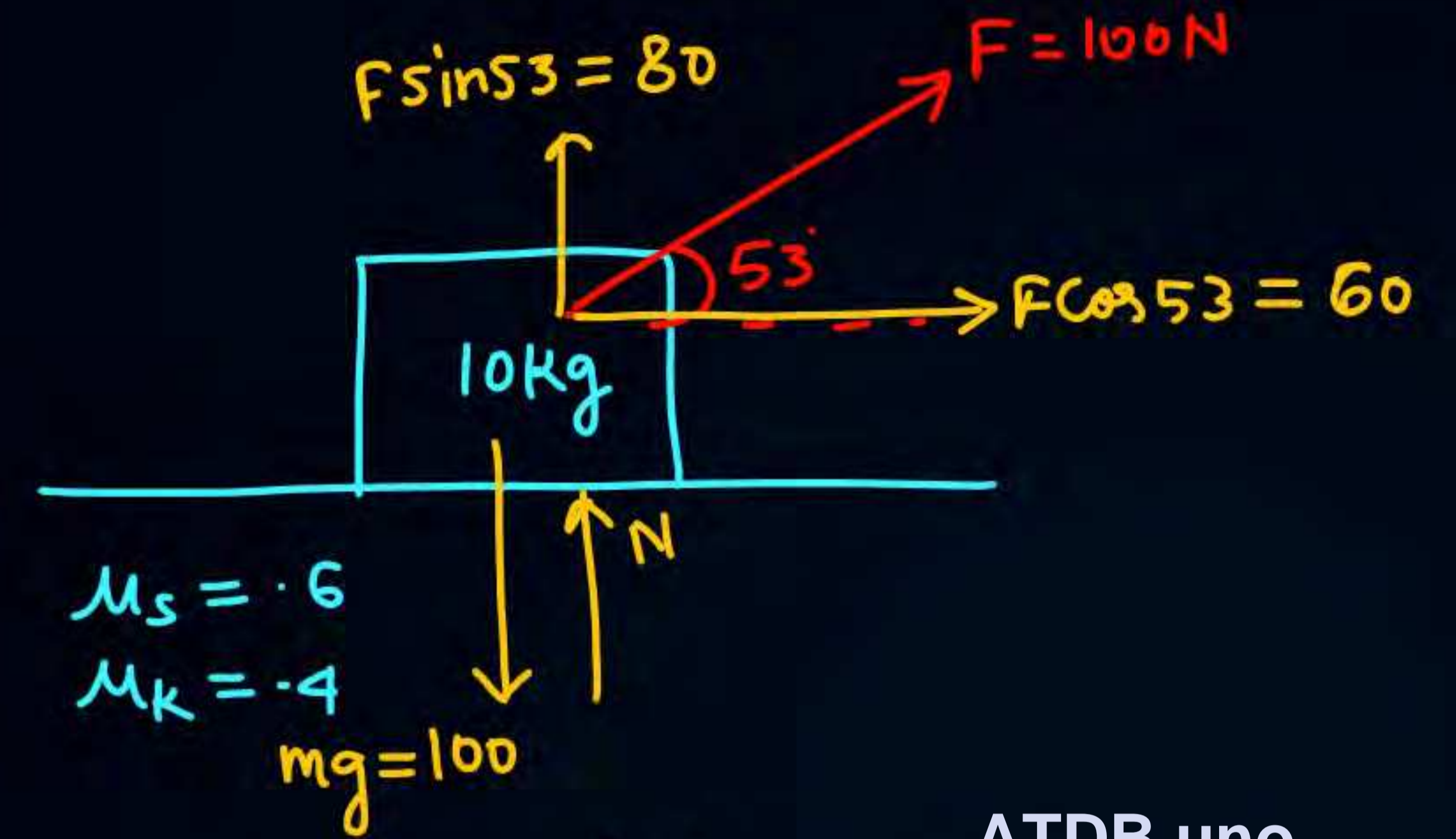

$\mu_s = 0.6$
 $\mu_k = 0.4$

ATDB.uno

$N = 20 \quad (f_s)_{\max} = 0.6 \times 20 = 12$
 $f_k = 0.4 \times 20 = 8$

$a = \frac{60 - 8}{10} = 5.2$

(b) find acc of block if it placed in lift moving upward with acc $a' = 2$ ground frame \uparrow

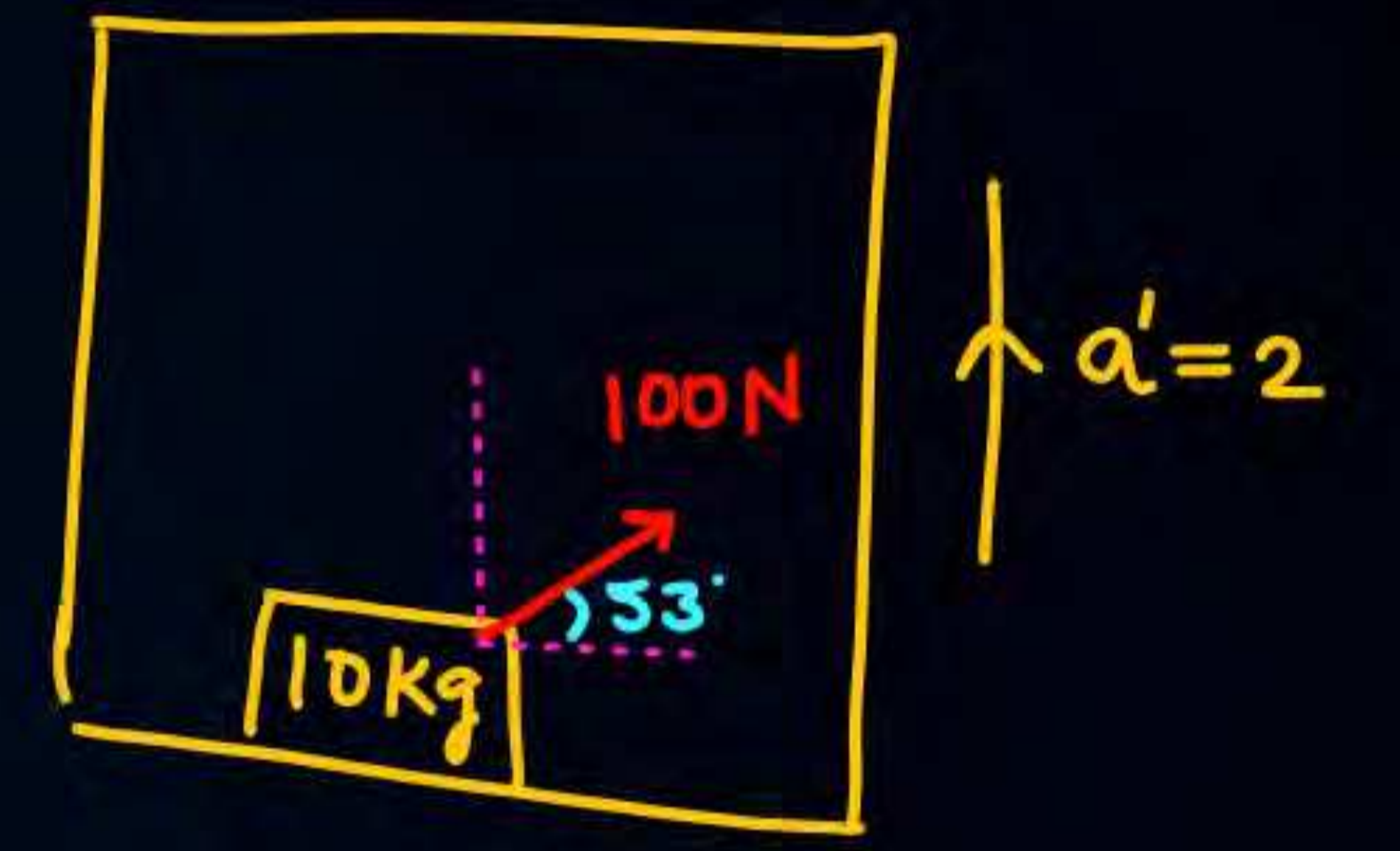



Q

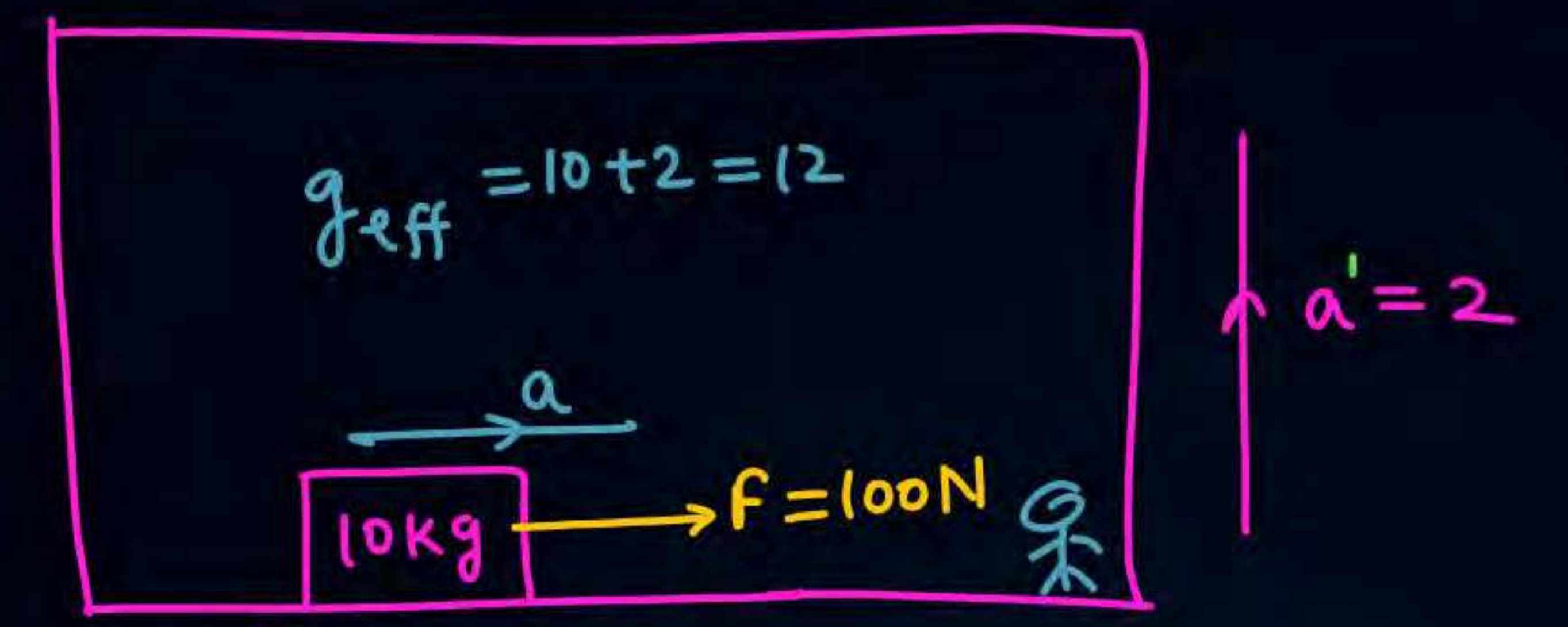

$\mu_s = 0.6$
 $\mu_k = 0.4$

$N = mg_{\text{eff}} = 10 \times 12 = 120$

$(f_s)_{\text{max}} = 0.6 \times 120 = 72$

$f_k = 0.4 \times 120 = 48$

$a = \frac{100 - 48}{10} = 5.2$

Acc of 10kg block
 in ground frame
 $= 5.2\hat{i} + 2\hat{j}$

or

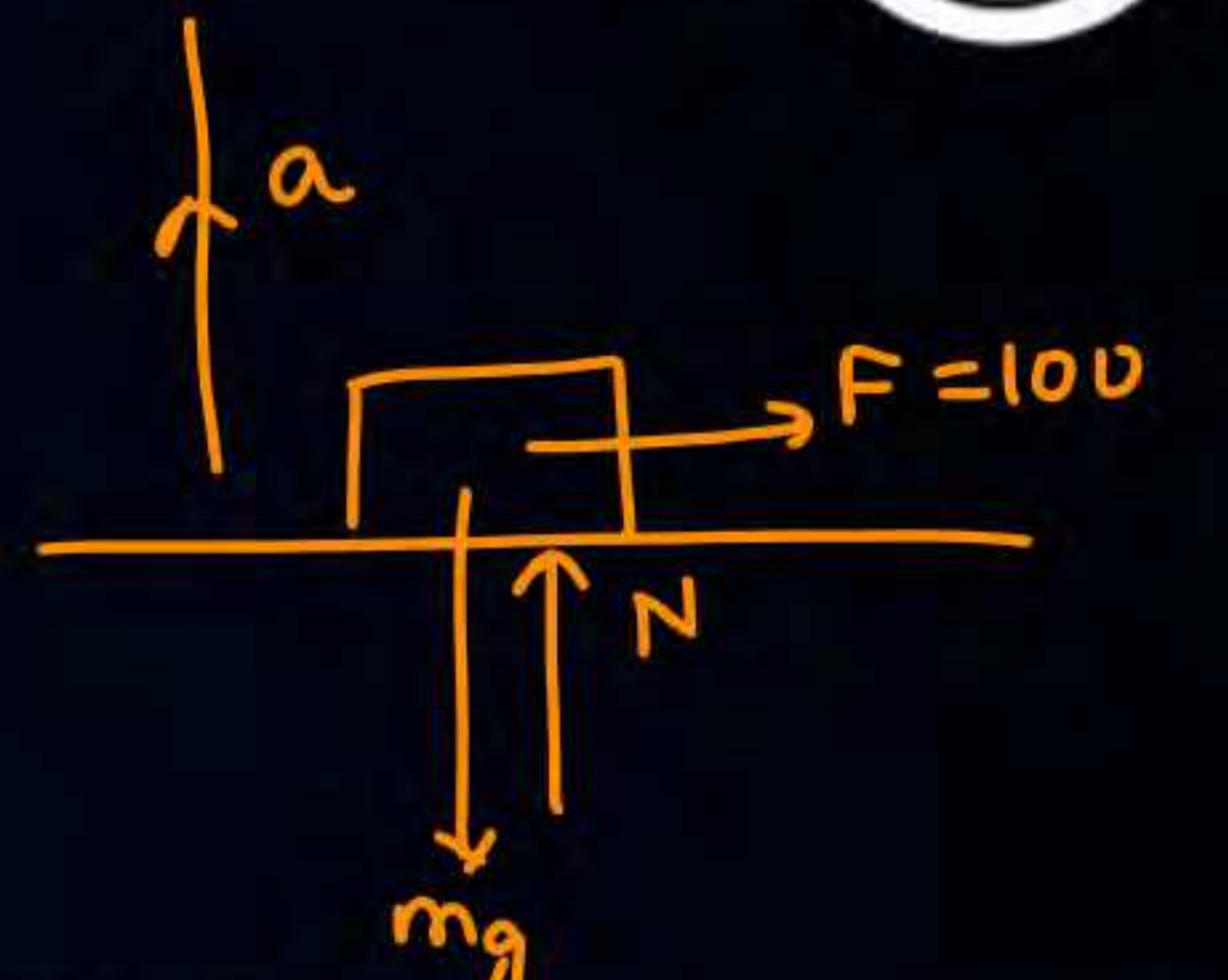

$N - mg = ma$

$N - 100 = 10 \times 2 \Rightarrow N = 120$

$a_{\text{net}} = \sqrt{(5.2)^2 + 2^2}$



Q

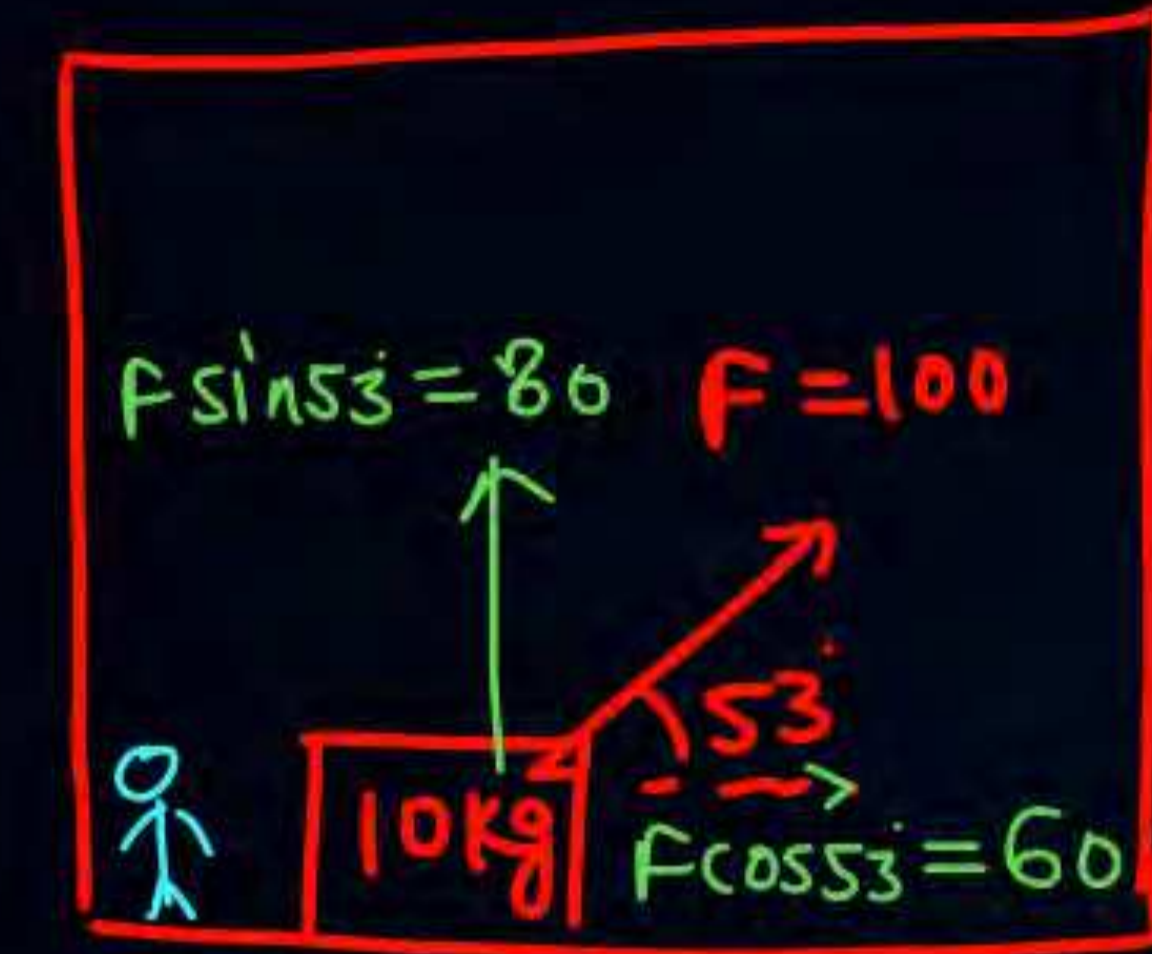

$a' = 2$

$N + 80 = m g_{\text{eff}}$ (wrt lift)

$N + 80 = 10 \times 12$

$N = 40$

$(f_s)_{\text{max}} = \mu \times 40 = 24$

$f_k = \mu_k \times 40 = 16$

ATDB.uno

$a = \frac{60 - 16}{10} = 4.4$

wrt ground

$N + 80 - 100 = 10 \times 2$

$N = 40$

$\vec{a}_{\text{block}} = 4.4 \hat{i} + 2 \hat{j}$

$a_{\text{block}} = \sqrt{(4.4)^2 + 2^2}$



Q

M₃ floor (Top View)

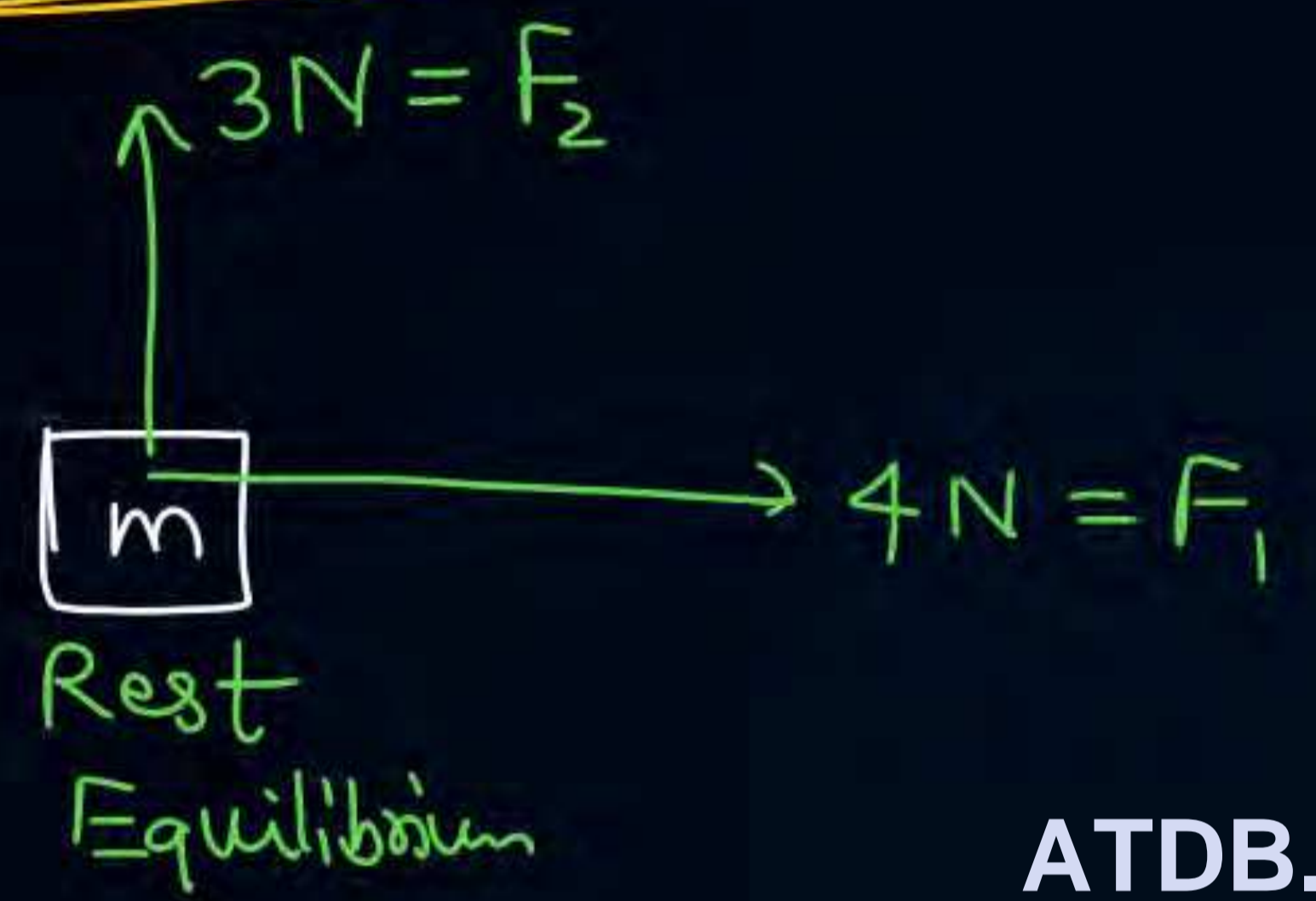

Solⁿ

$mg \rightarrow$ अंदर
 $N \rightarrow$ बाहर

ATDB.uno

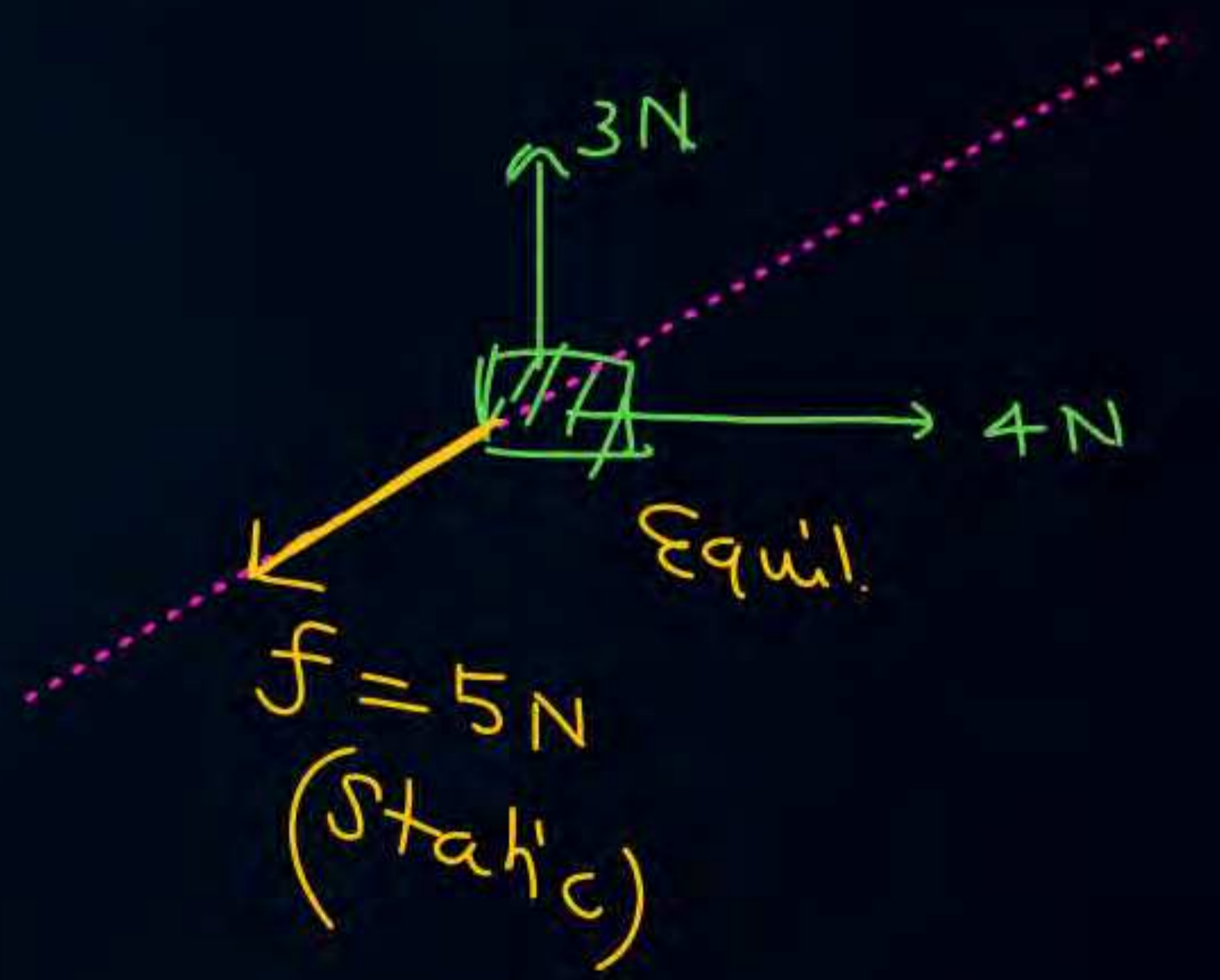



Q

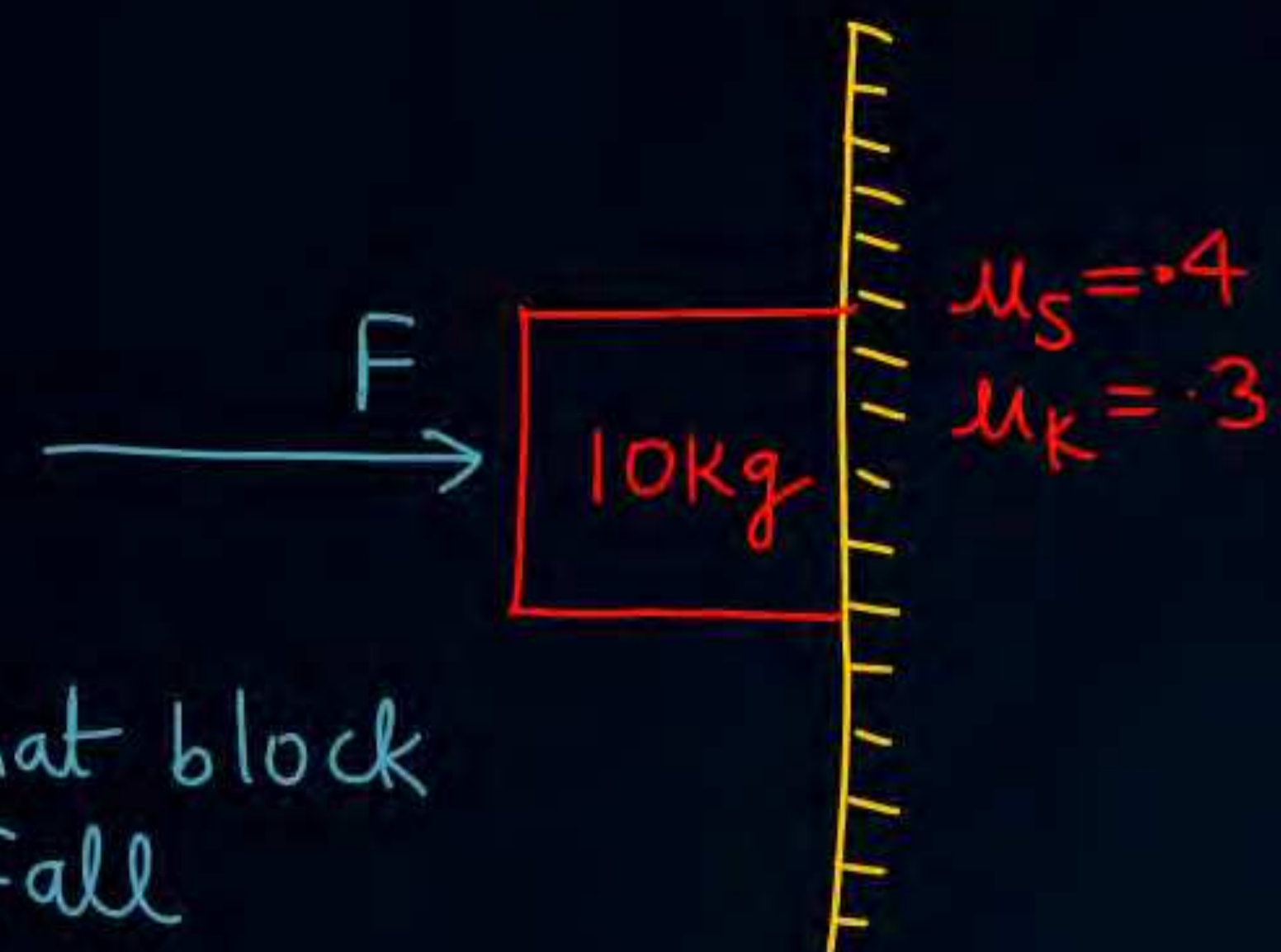

① find f_{\min} so that block does not fall

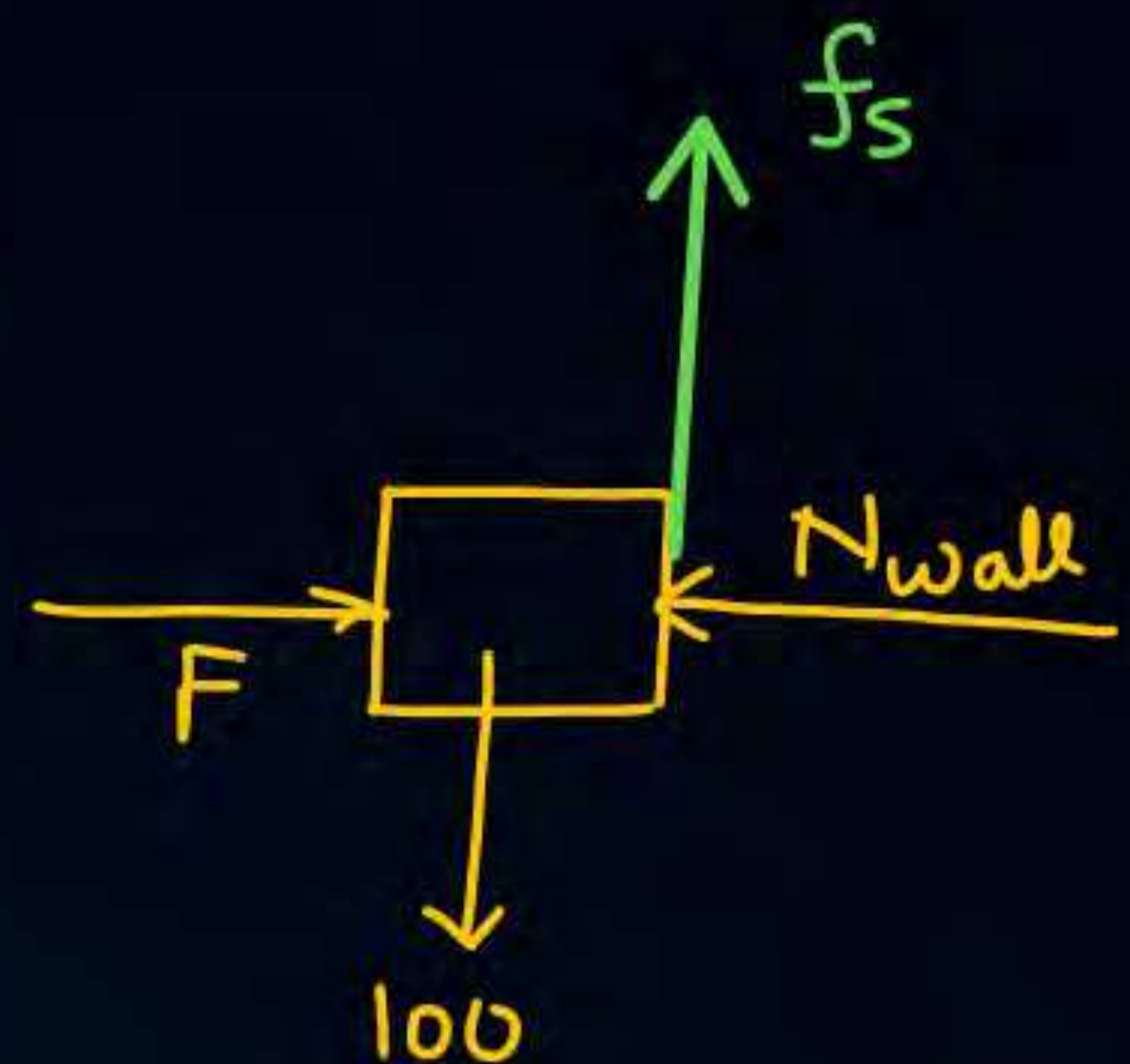
Solⁿ

$$F = N_{wall}$$

ATDB.uno



Q

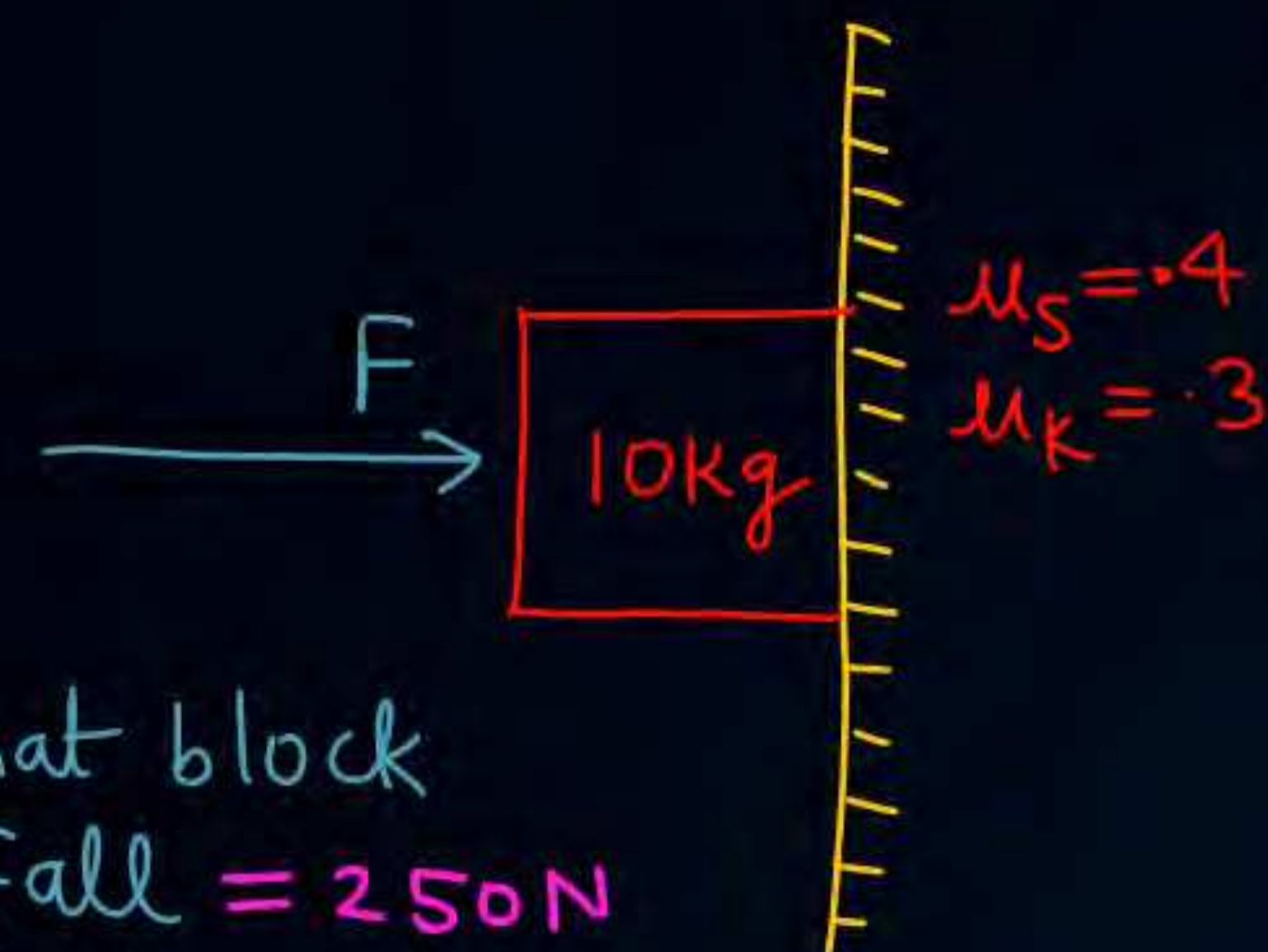

① find F_{\min} so that block does not fall = 250N

② find F_{\max} so that block fall = 249.99999999...

↳ Ans = 250

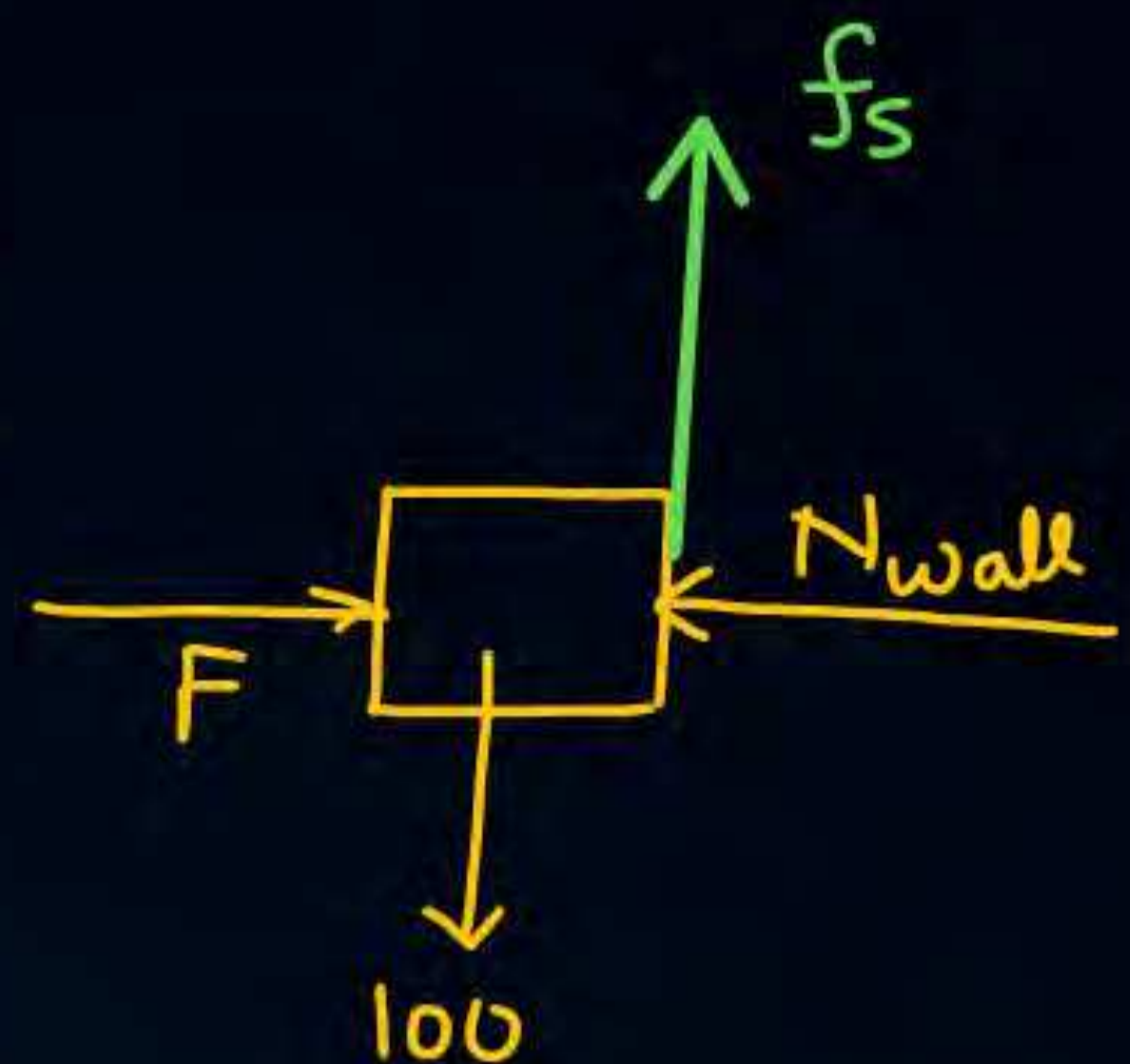
solⁿ

$$F = N_{\text{wall}}$$

$$100 = f_s$$

$$(f_s)_{\max} = \mu_s N_{\text{wall}}$$

$$(f_s)_{\max} = \mu_s F$$

$$100 = 0.4 \times F$$

$$\boxed{F = 250}$$

$F \geq 250 \Rightarrow$ Block move
 नहीं करेगा

$F < 250 \Rightarrow$ Block slide
 और move करेगा

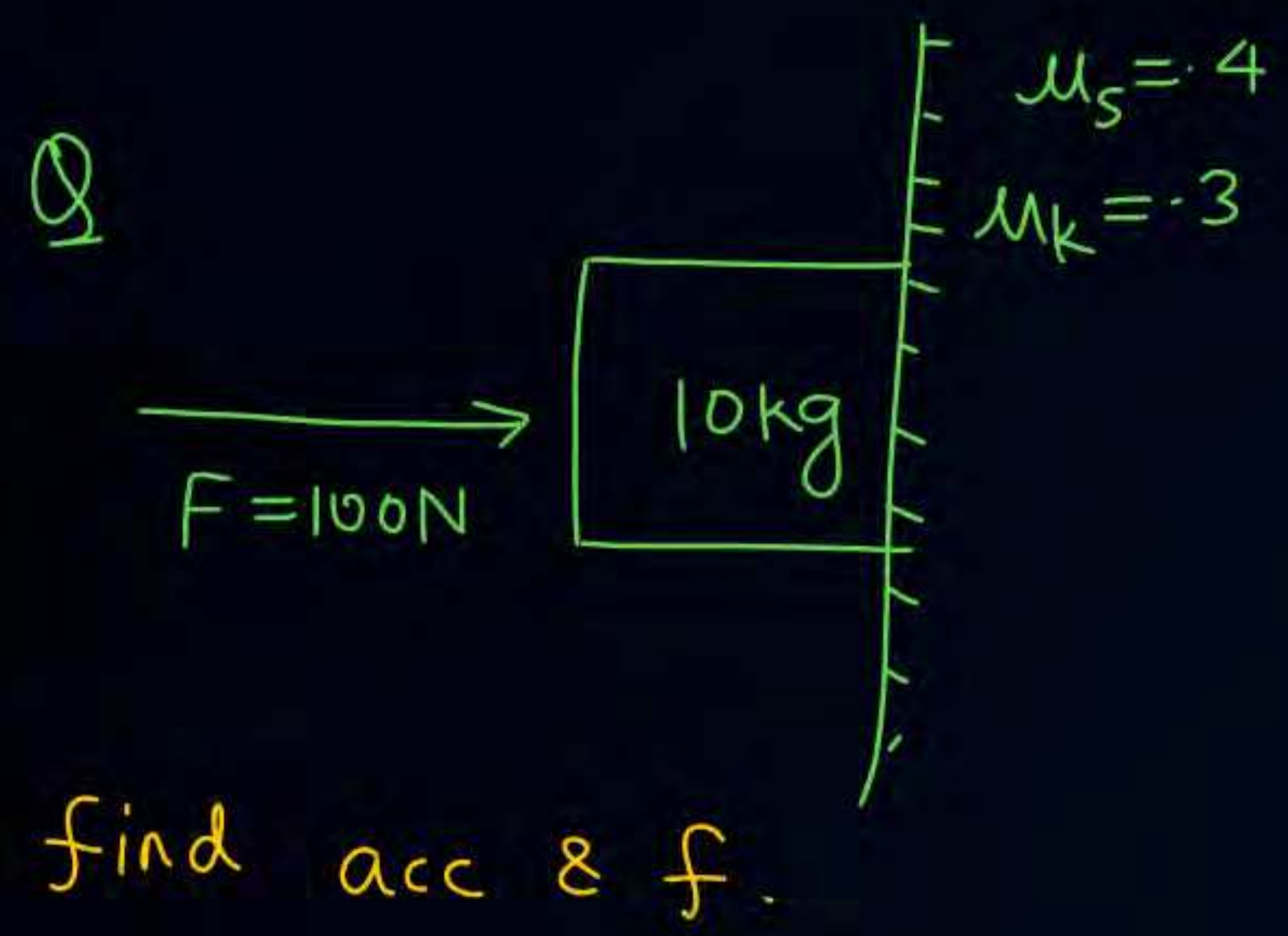

Solⁿ

move ✓

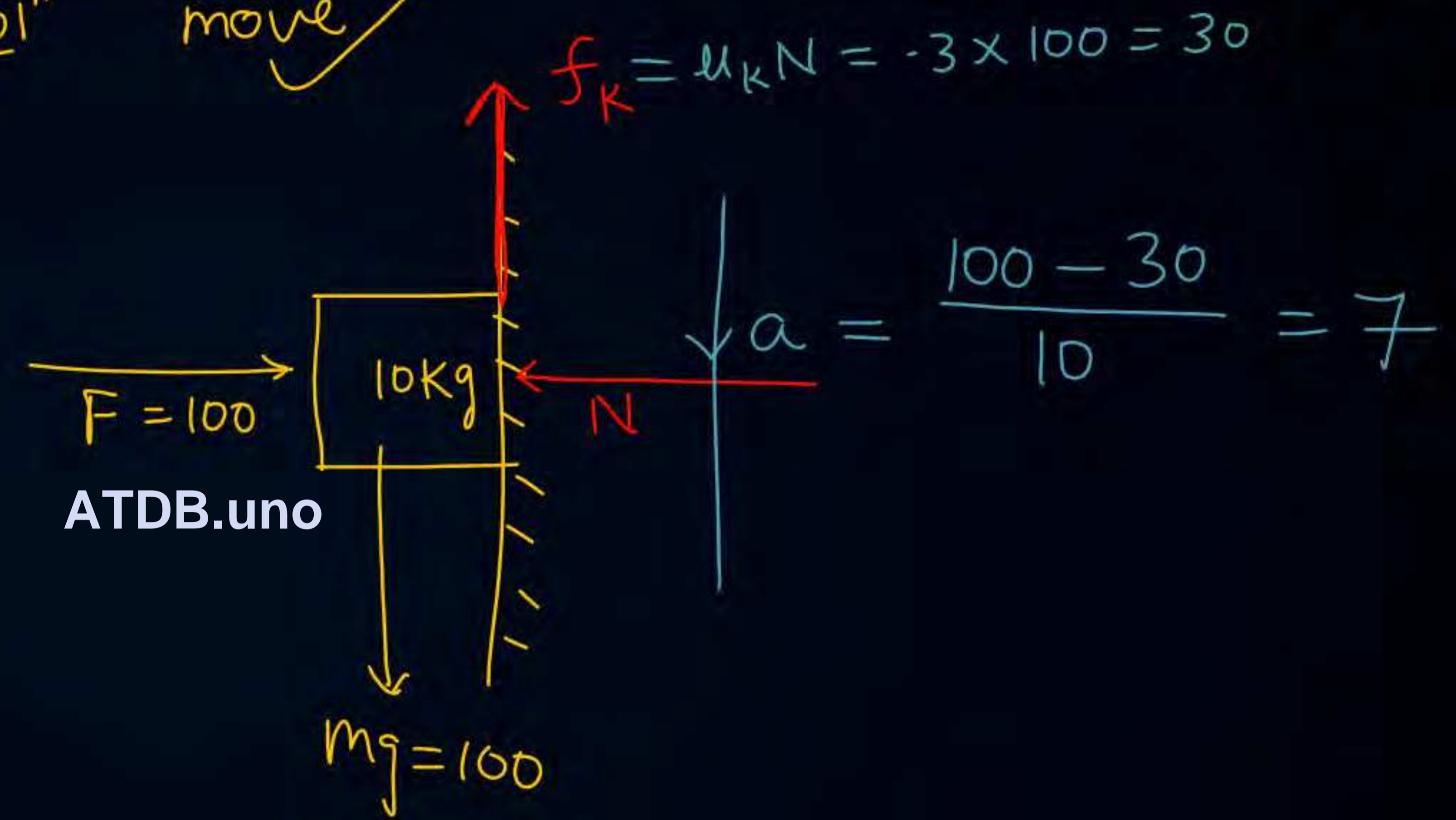

ATDB.uno

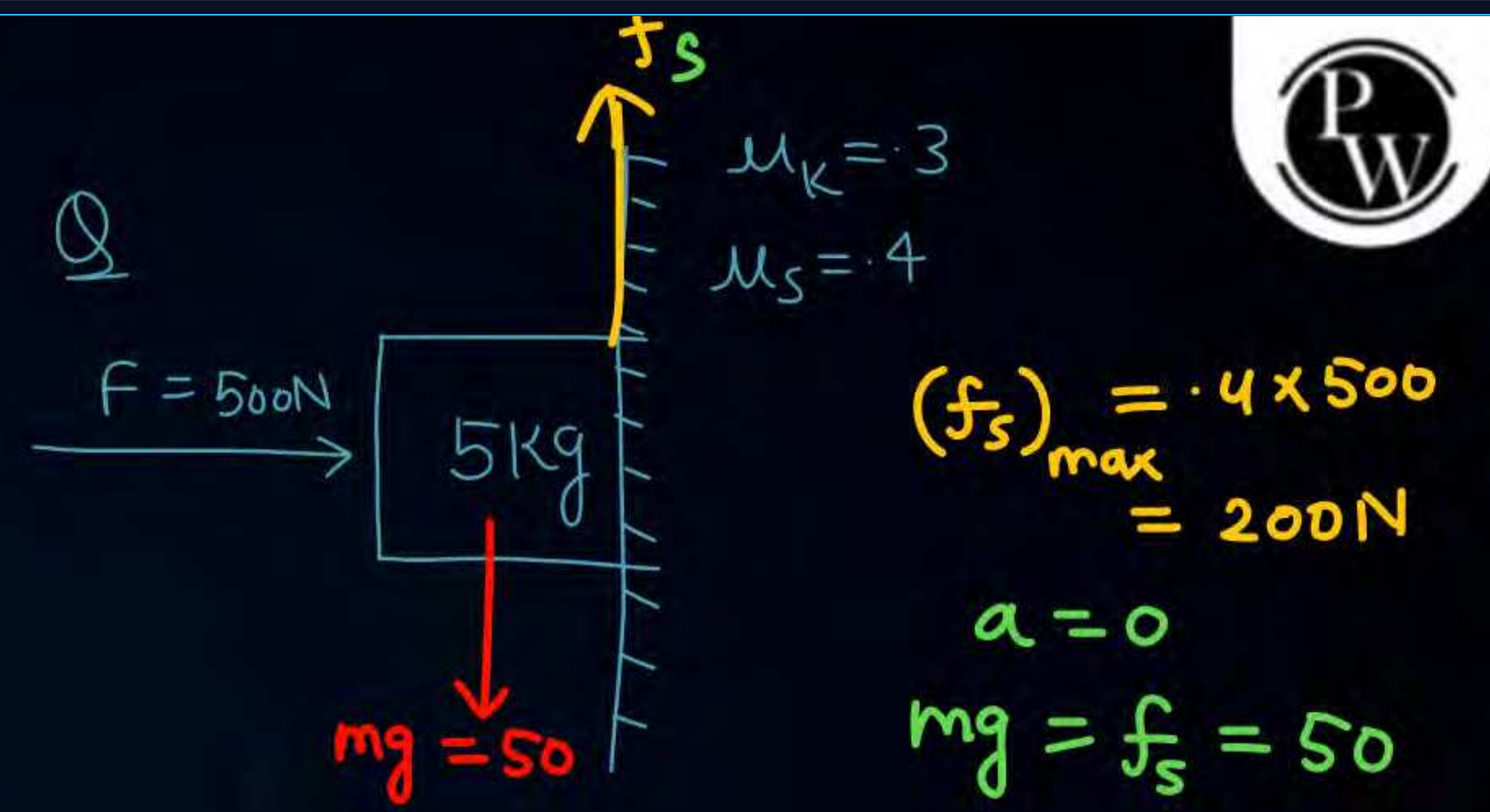
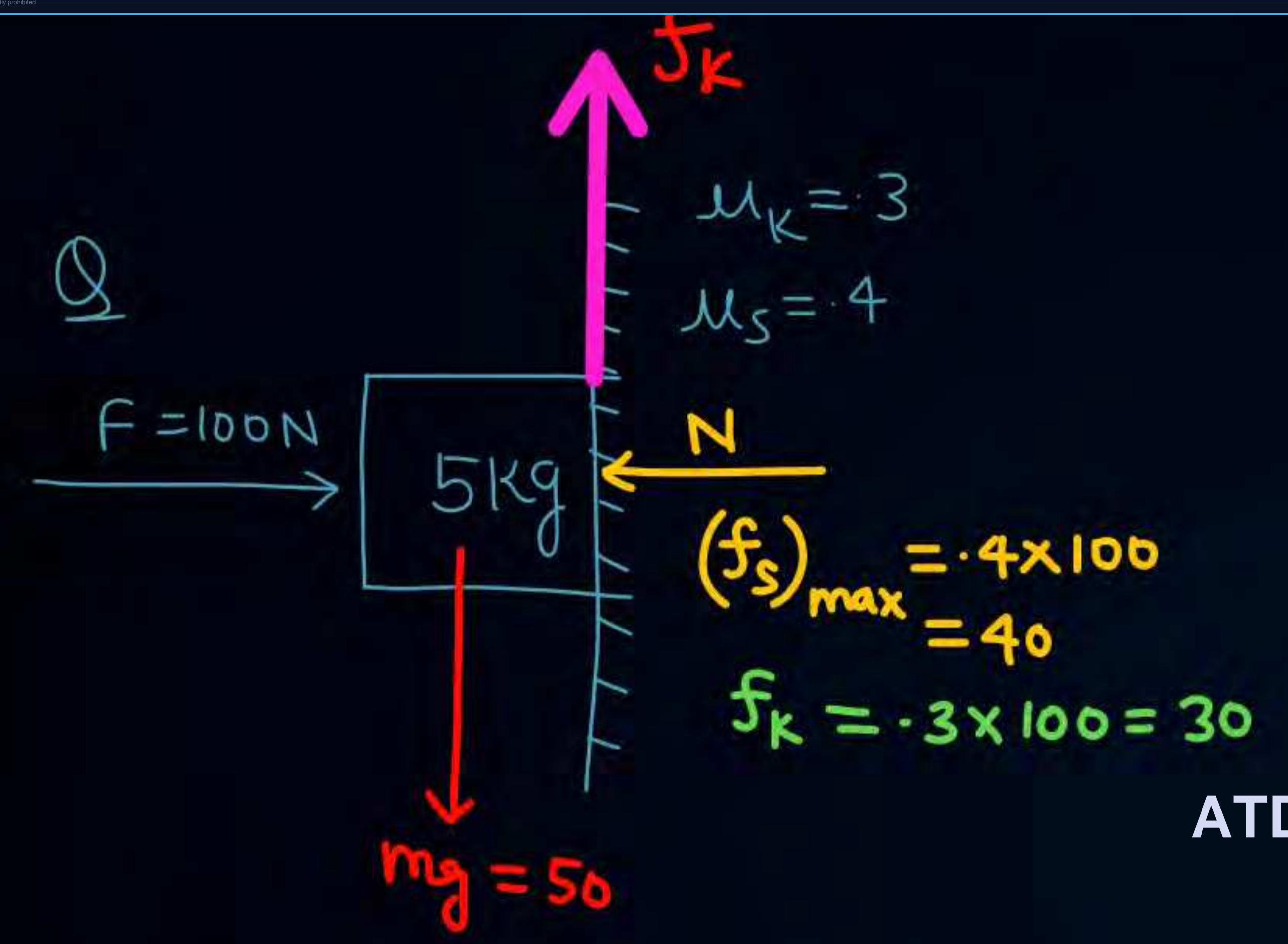

ATDB.uno

$$a = \frac{mg - f_k}{m} = \frac{50 - 30}{5} = 4$$



Q



$$\mu_s = 0.4$$

$$\mu_k = 0.3$$

$$(f_s)_{\max} = 0.4 \times 400 = 160$$

$$f_k = 0.3 \times 400 = 120$$

ATDB.uno

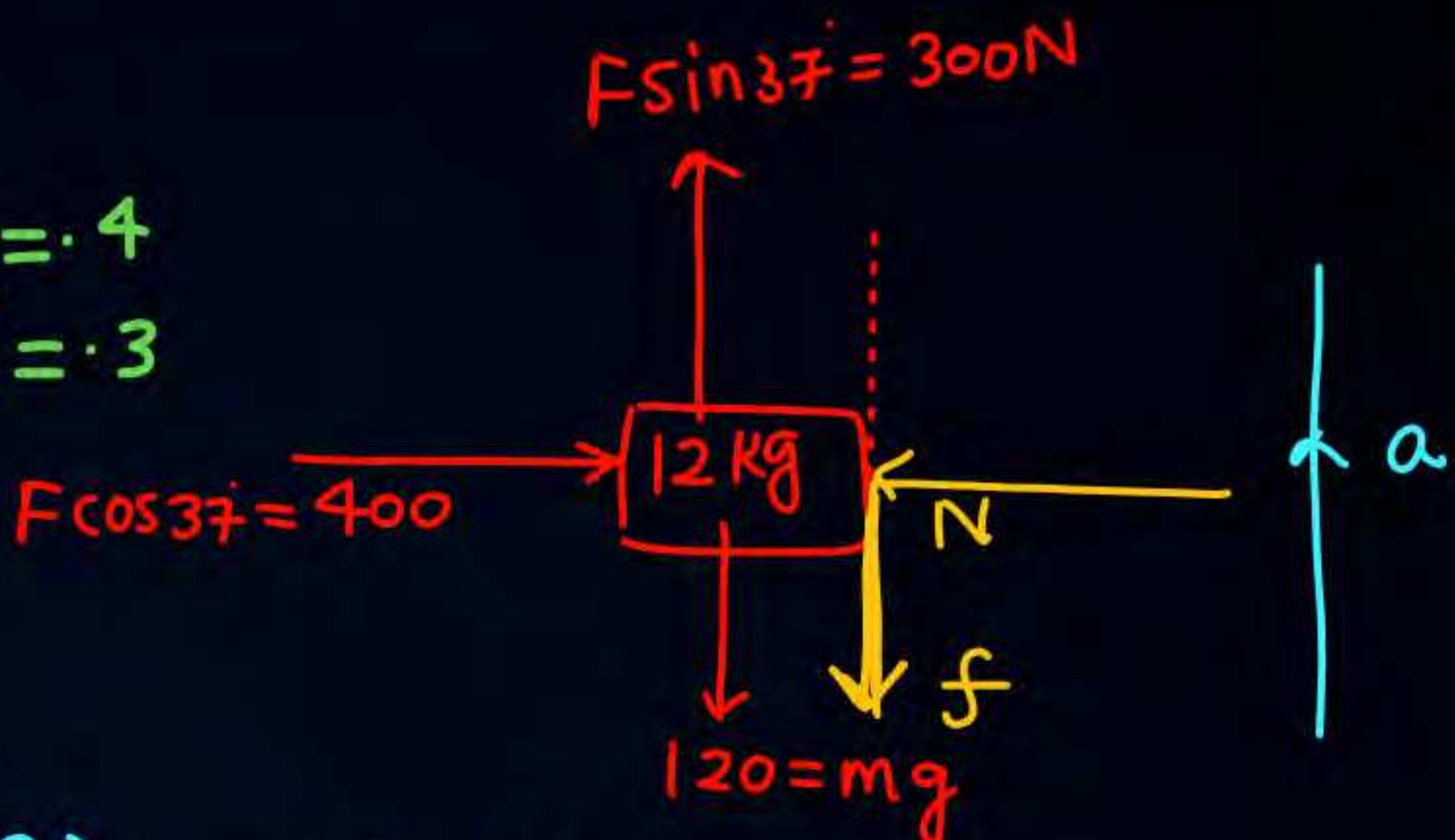

$$a = \frac{300 - 120 - f_k}{12}$$

$$a = \frac{300 - 120 - 120}{12}$$

$$a = 5 \text{ मी/से}^2$$

$$f = 120 \text{ (kinetic friction)}$$

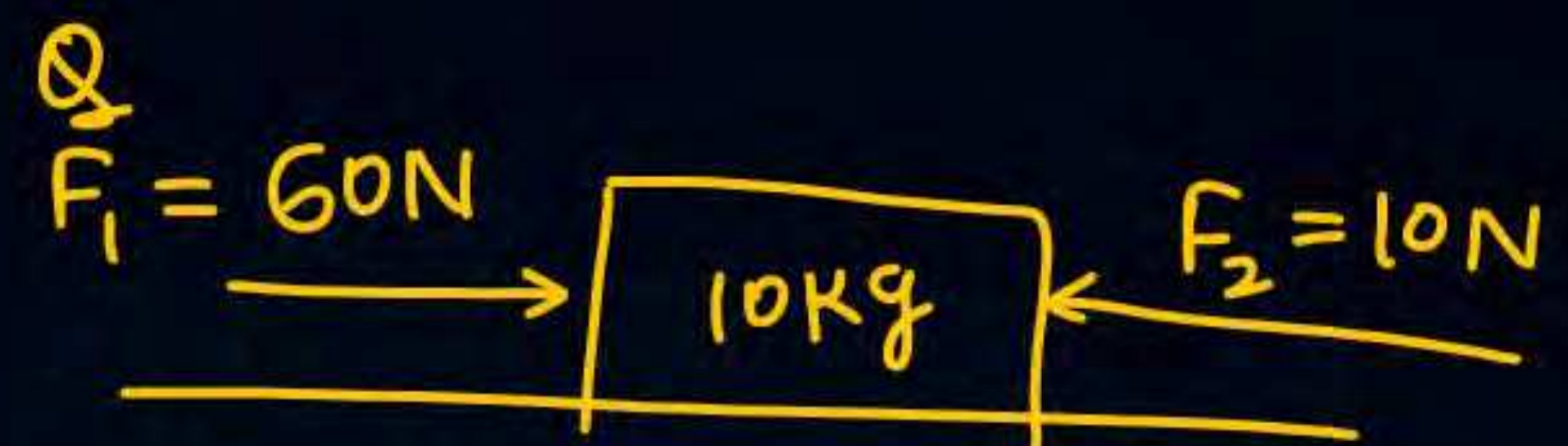

$$\mu_s = 0.4$$

$$\mu_k = 0.3$$

$$(f_s)_{\max} = 40$$

$$f_k = 30$$

ATDB.uno

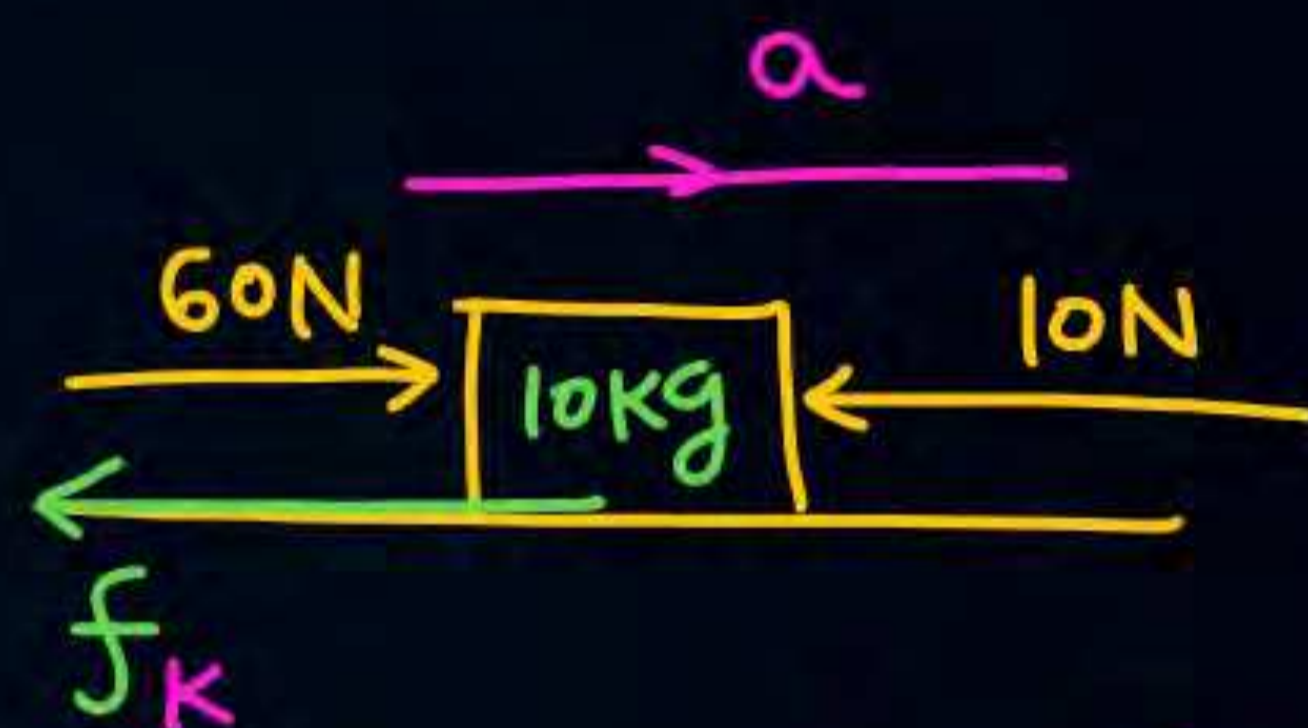

$$a = \frac{60 - 10 - f_k}{10}$$

$$a = \frac{60 - 10 - 30}{10}$$

$$a = 2$$

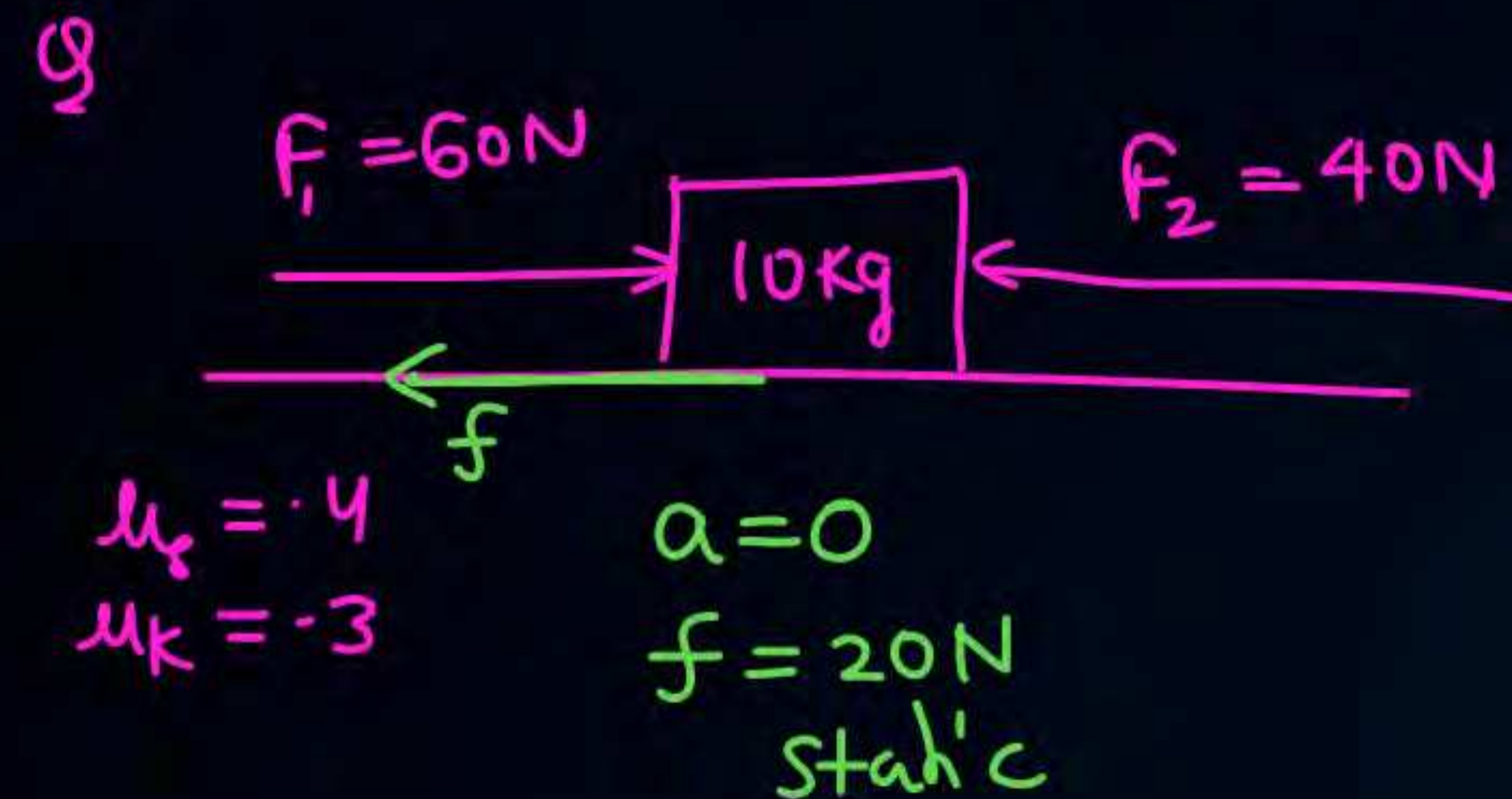

ATDB.uno

Q

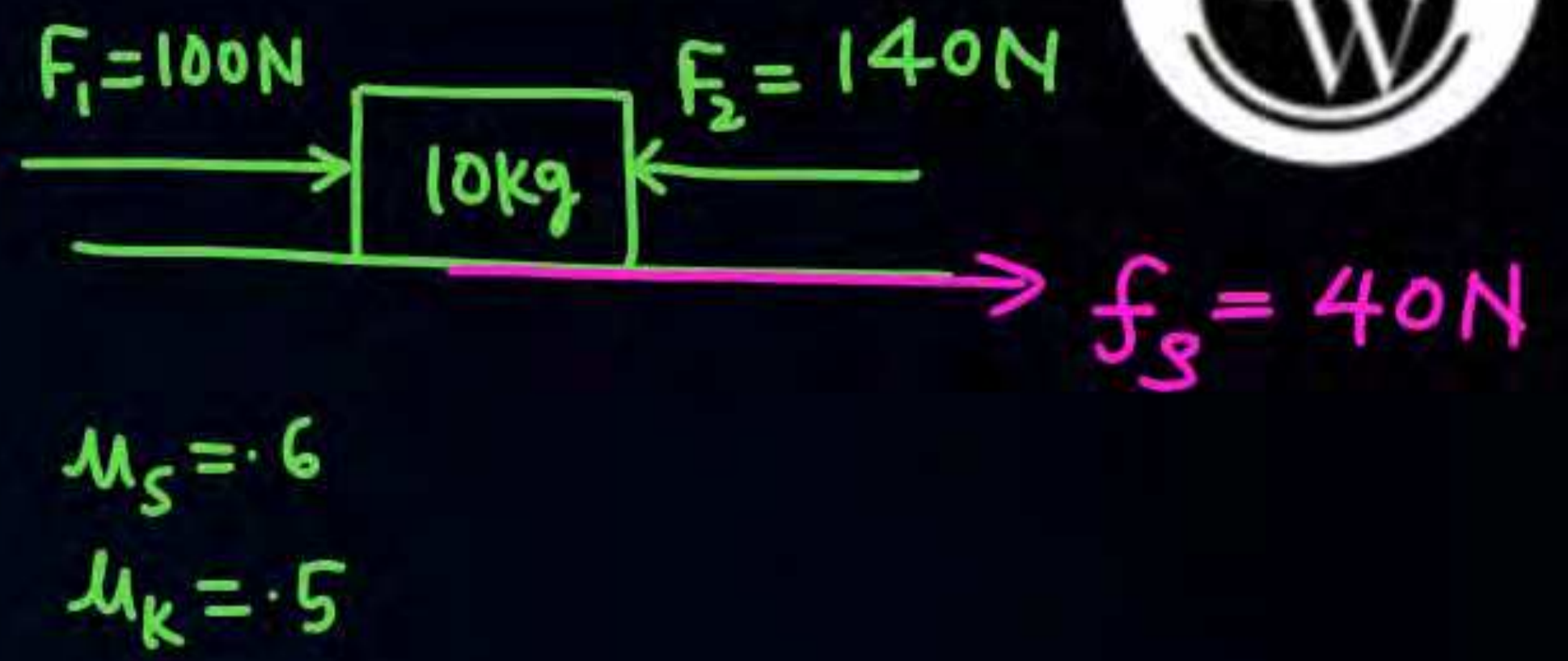
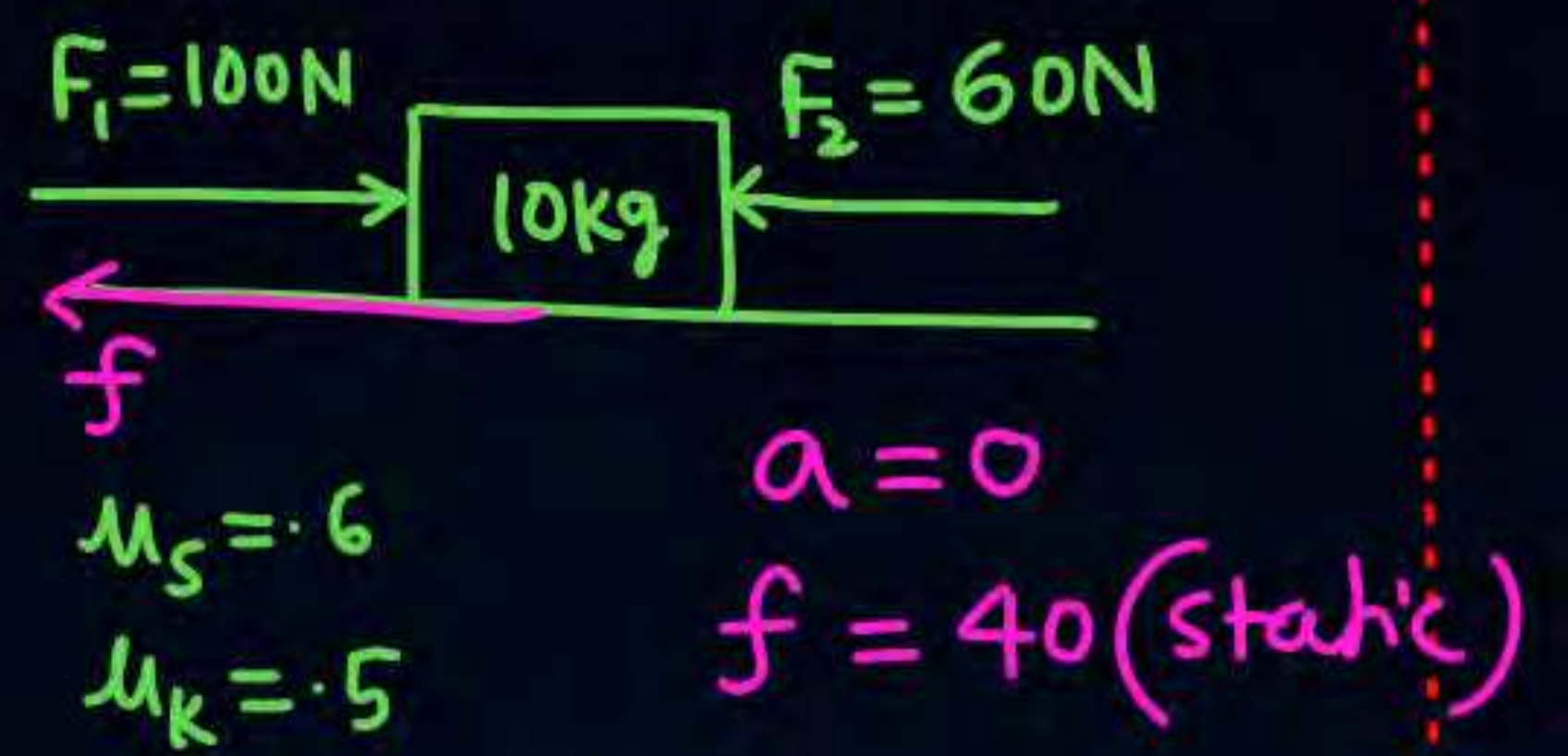
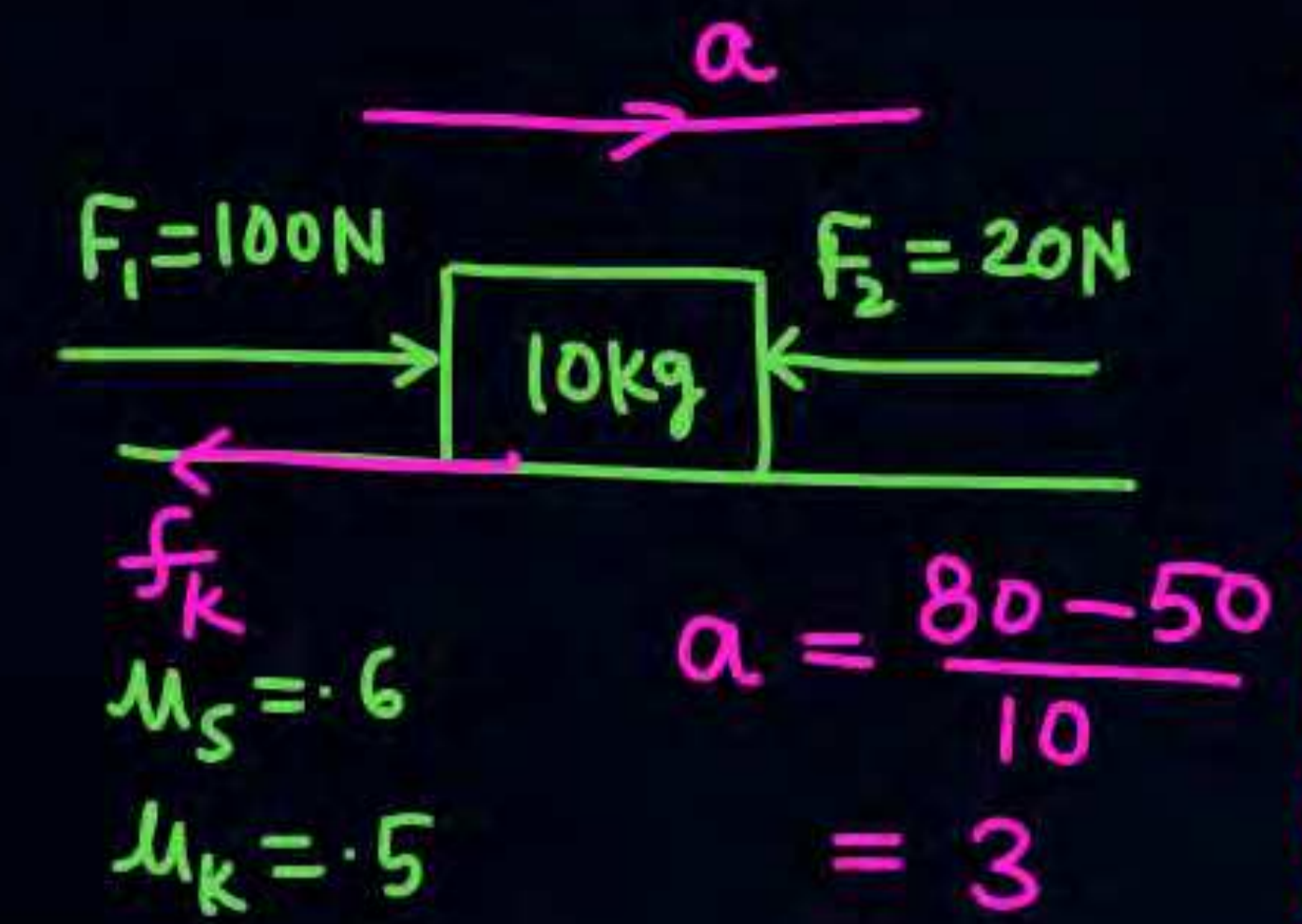

ATDB.uno

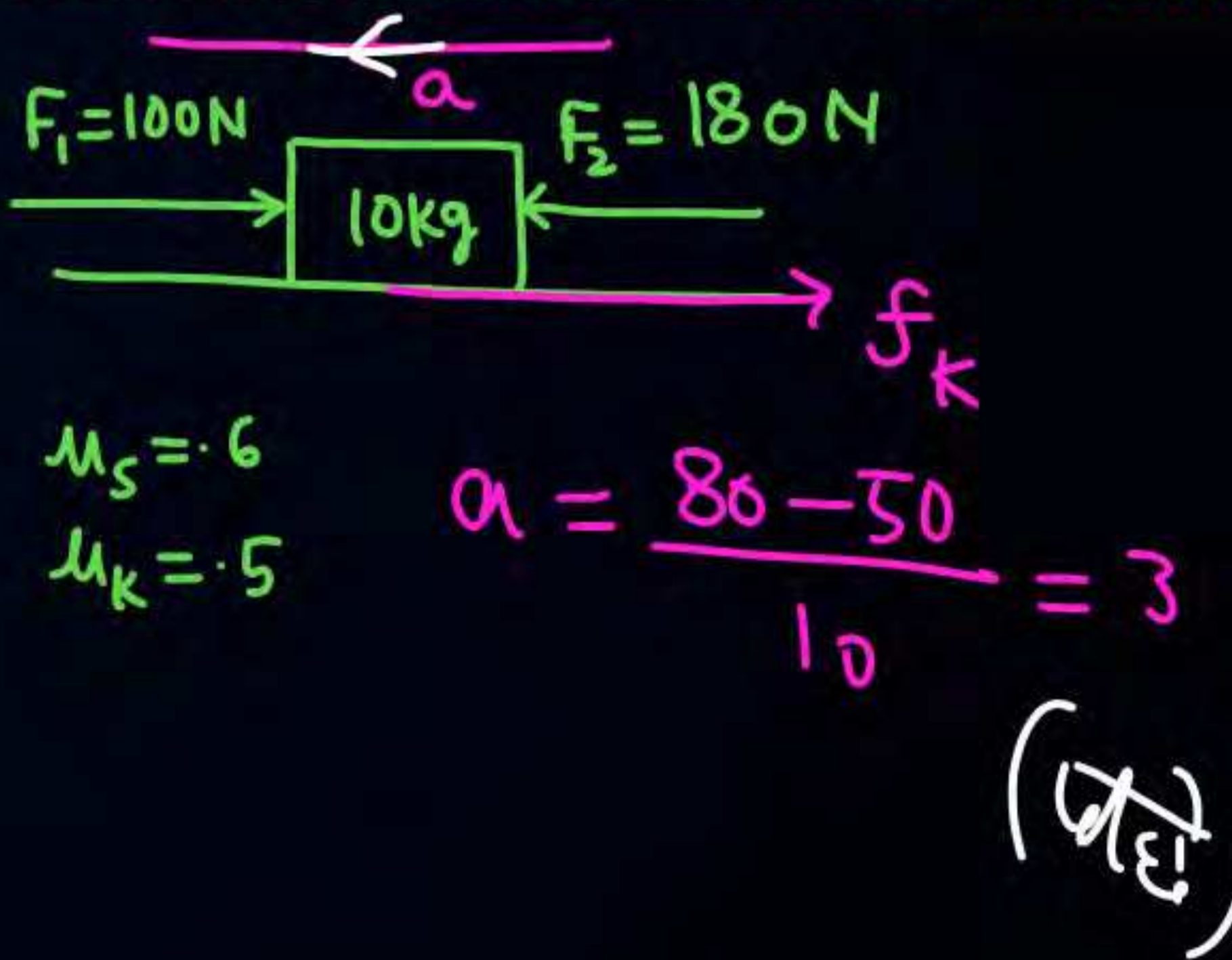
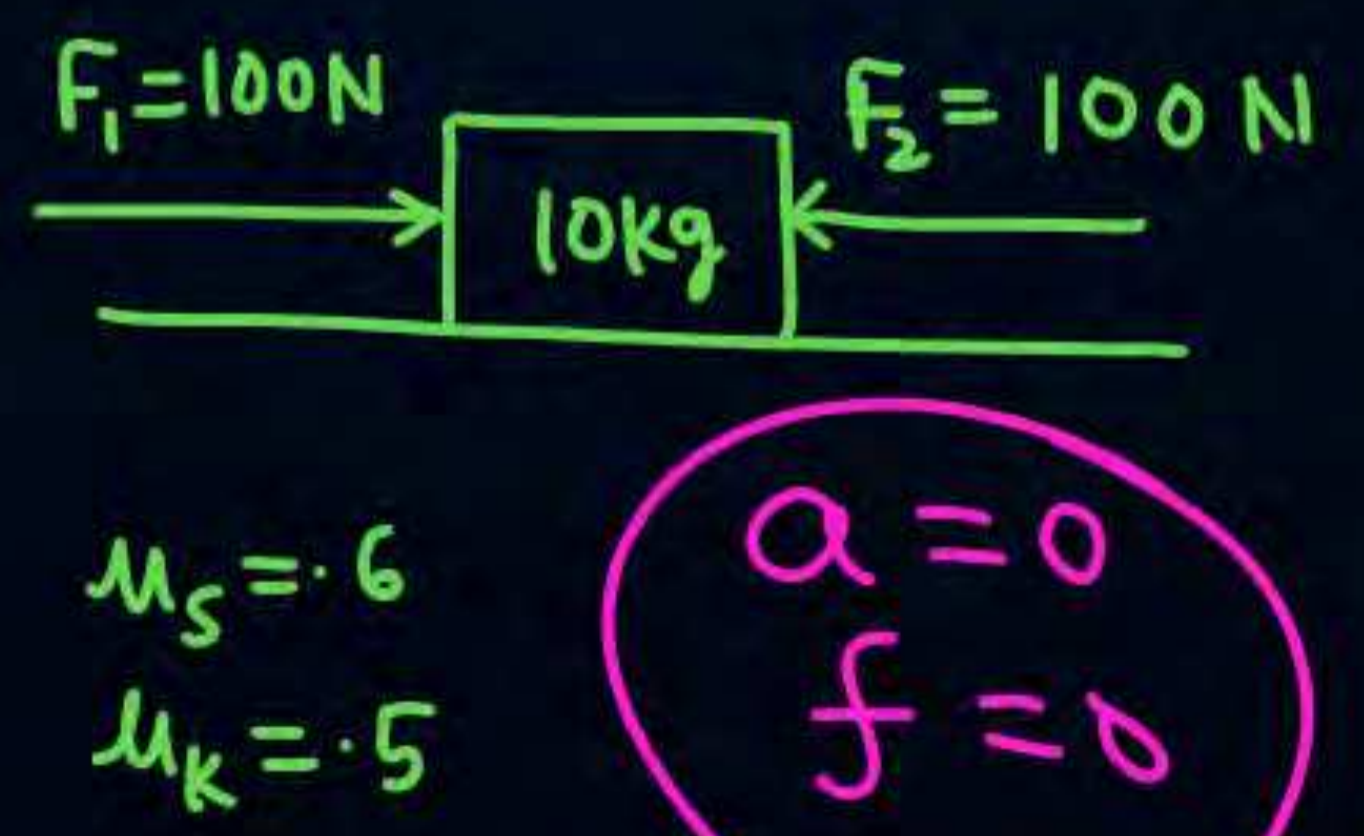
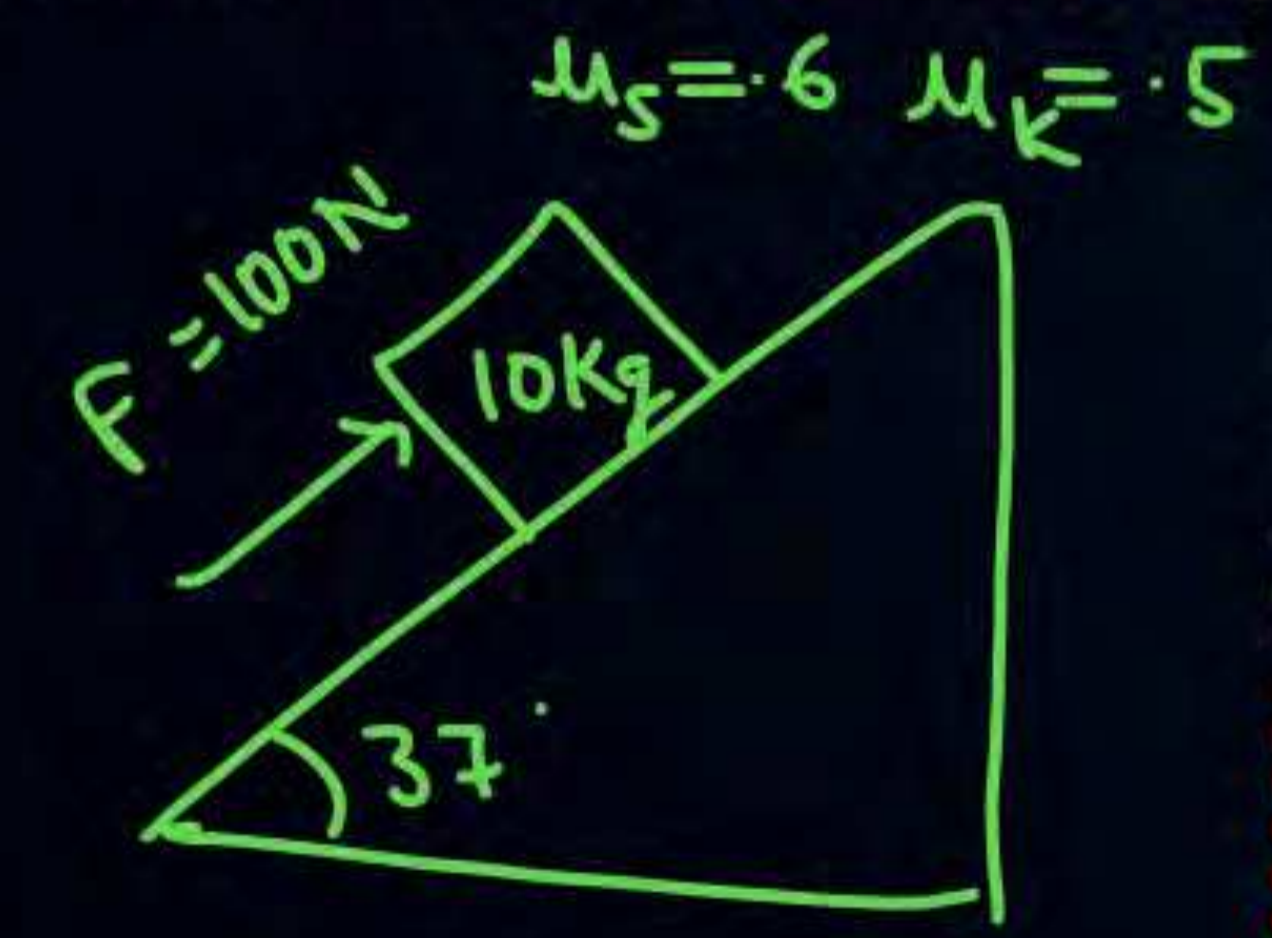

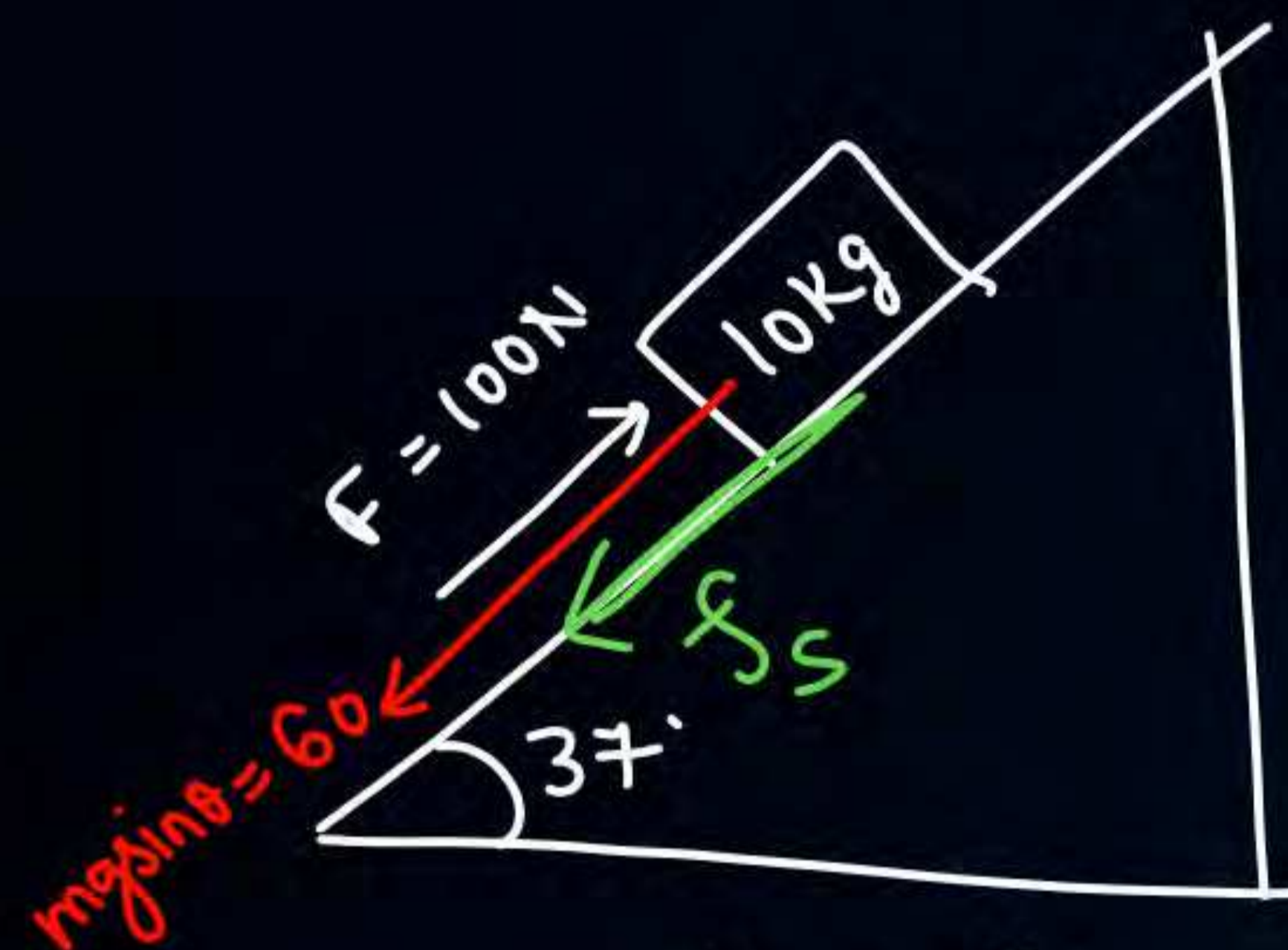

$$\mu_s = 0.6$$

$$\mu_k = 0.5$$

$$\begin{aligned} (f_s)_{\max} &= \mu_s N = \mu_s mg \cos \theta \\ &= 0.6 \times 80 = \underline{\underline{48}} \end{aligned}$$

$$a = 0$$

ATDB.uno

$$f_s = 40$$



Q

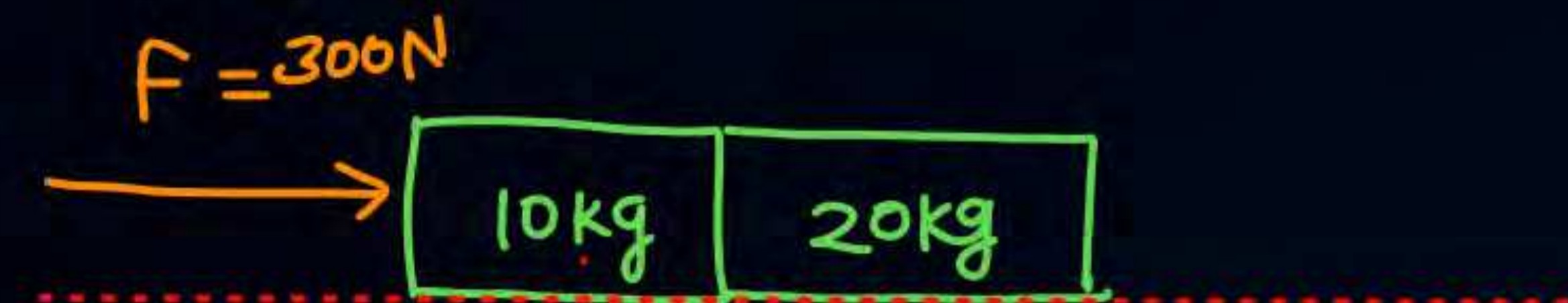

$$\mu_s = 0.6$$

$$\mu_k = 0.4$$

$$f_s = 40$$

$$\mu_s = 0.4$$

$$\mu_k = 0.3$$

$$f_k = 60$$

$$a = \frac{300 - f_1 - f_2}{10 + 20} = \frac{300 - 40 - 60}{30} = \frac{20}{3}$$

ATDB.uno

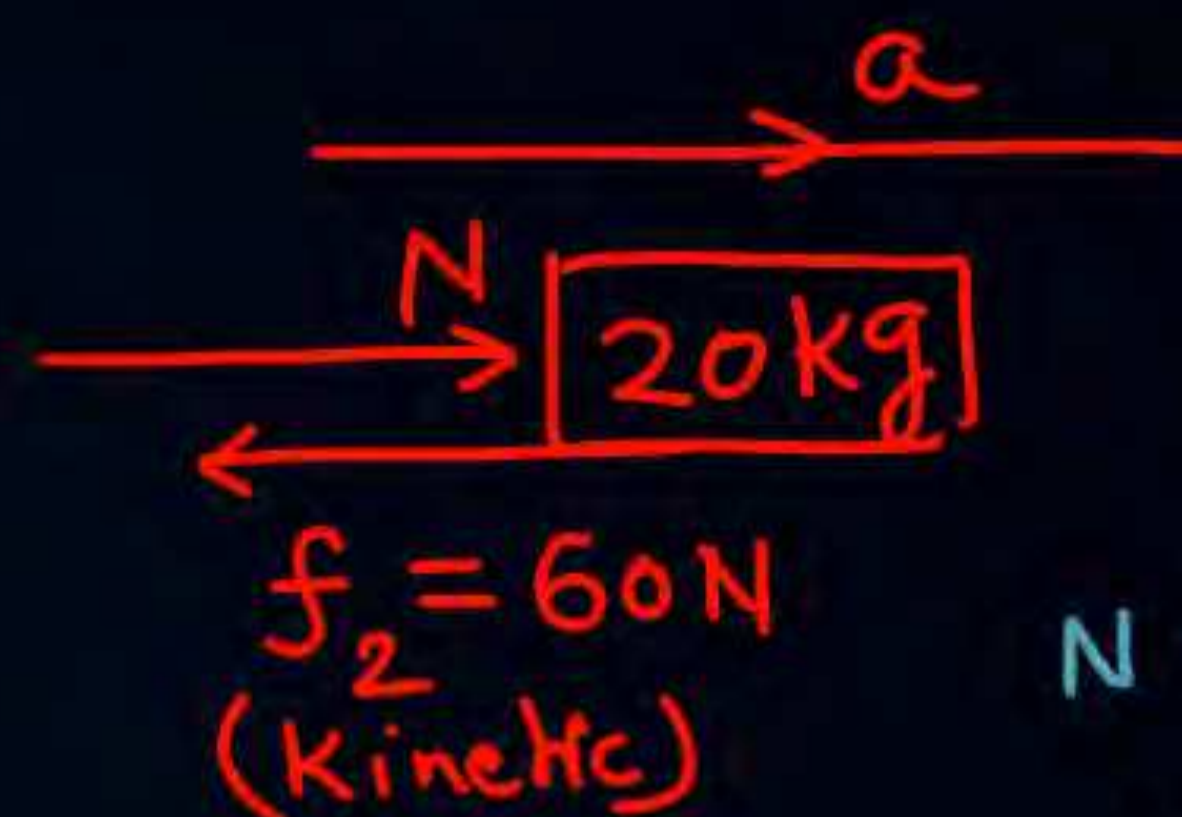

$$N - 60 = 20 \times \frac{20}{3}$$

$$N = 60 + \frac{400}{3}$$

$$N = \frac{180 + 400}{3}$$

$$N = \frac{580}{3}$$

Find normal contact force b/w block

$$f_k = \mu_k N = 0.4 \times 100 = 40$$

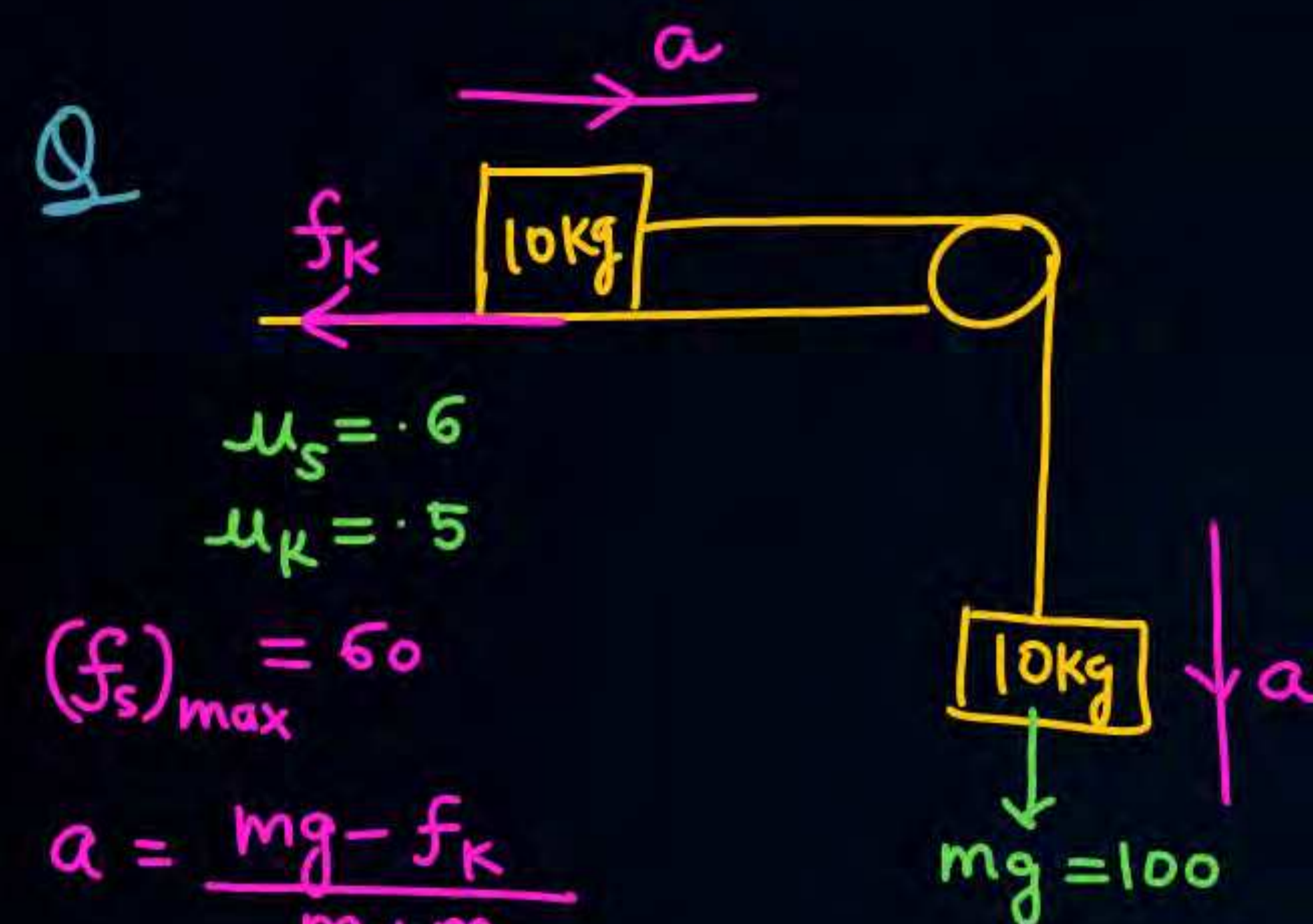

$$a = \frac{100 - 50}{20} = 2.5$$

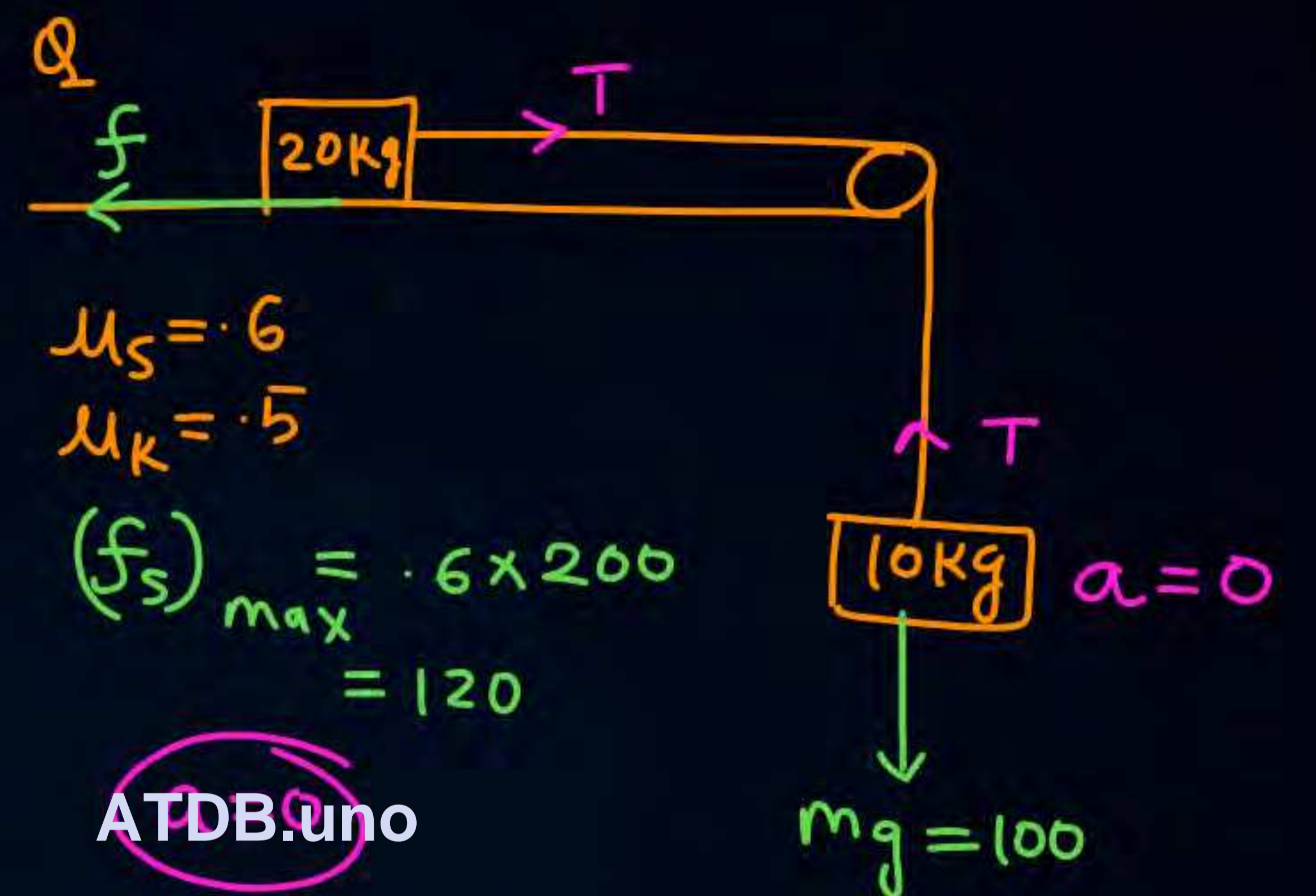

ATDB.uno

$$T = 100$$

$$T = f_s = 100$$

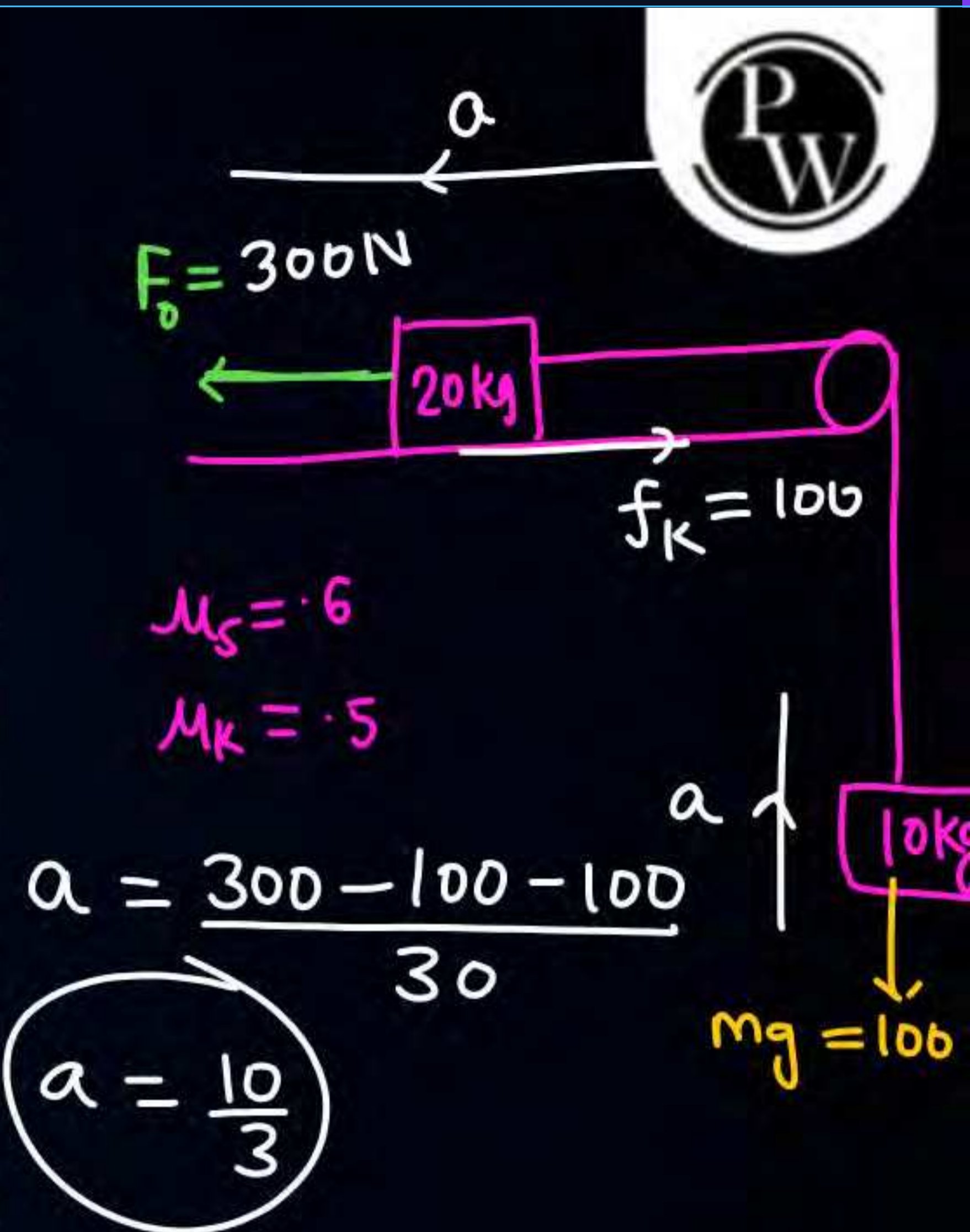
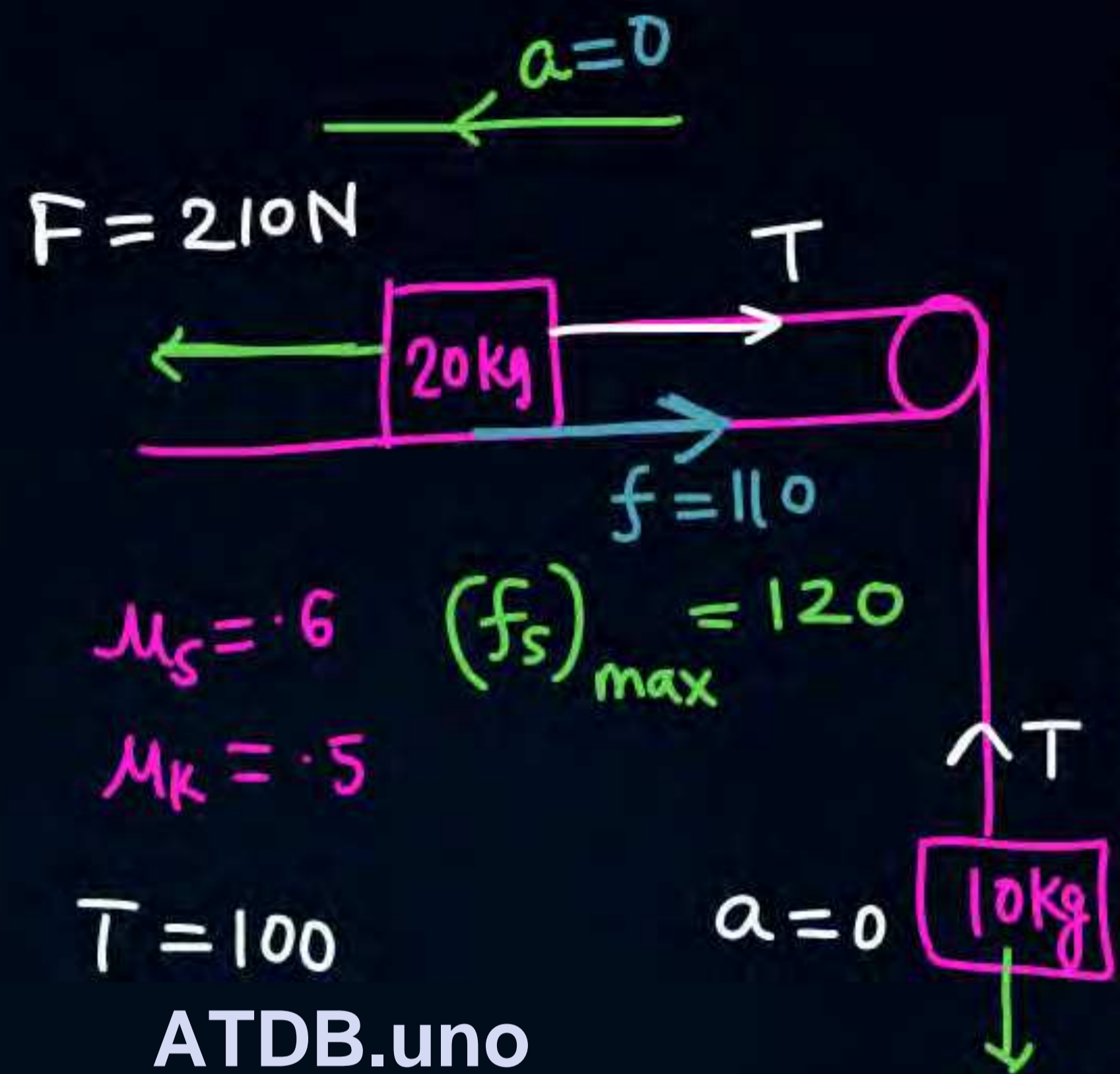
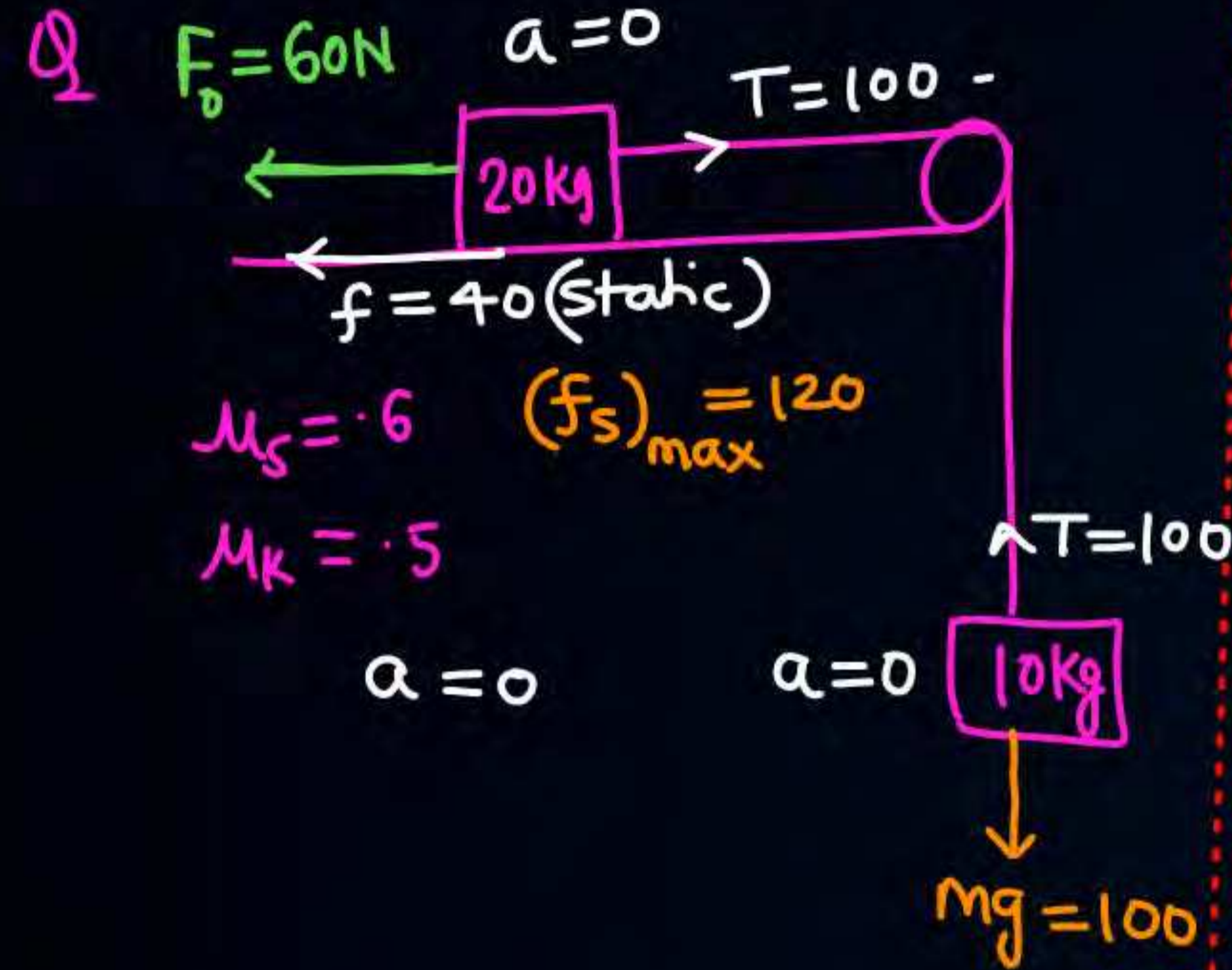

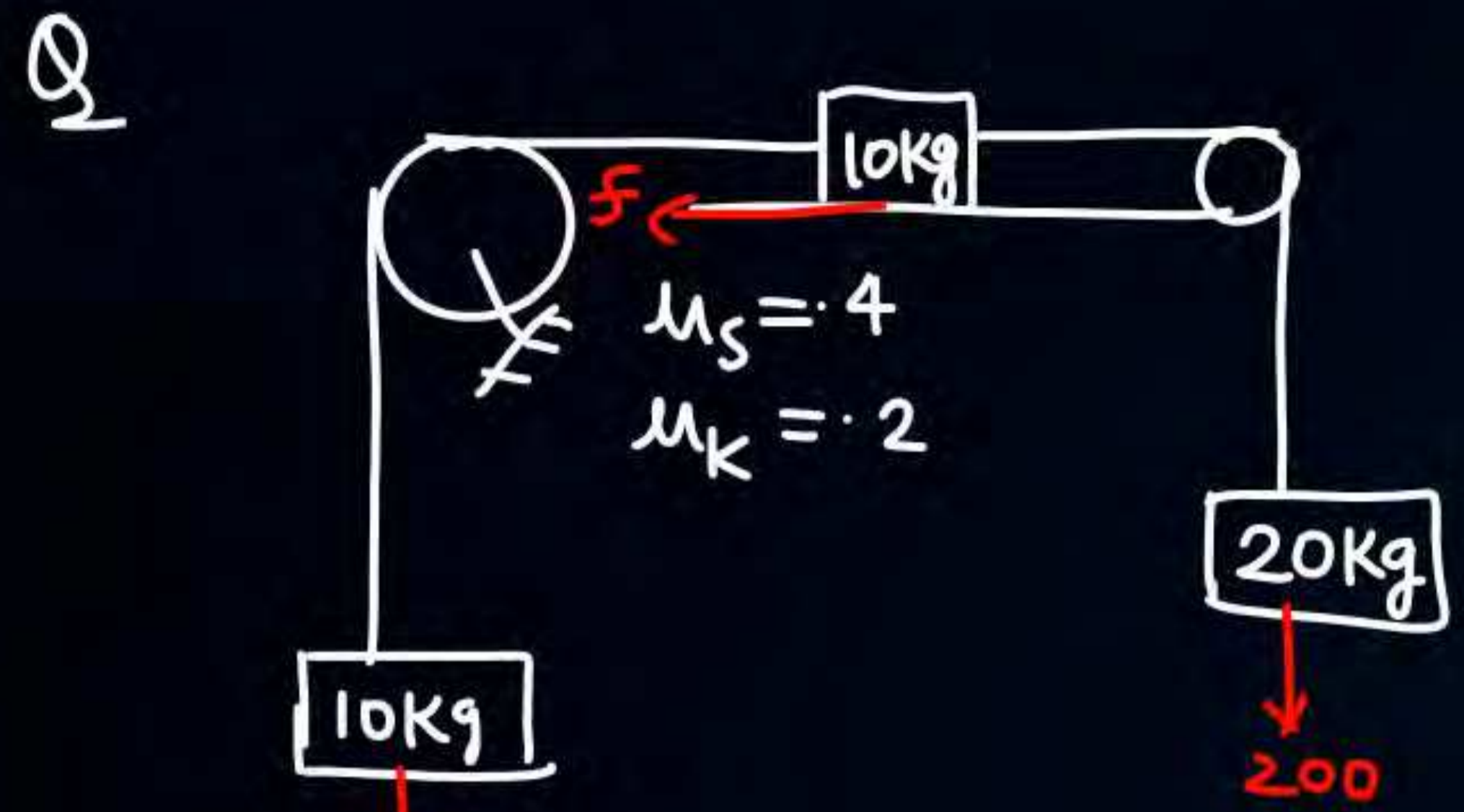

$$a = \frac{200 - 100 - 20}{40}$$

$a = 2$

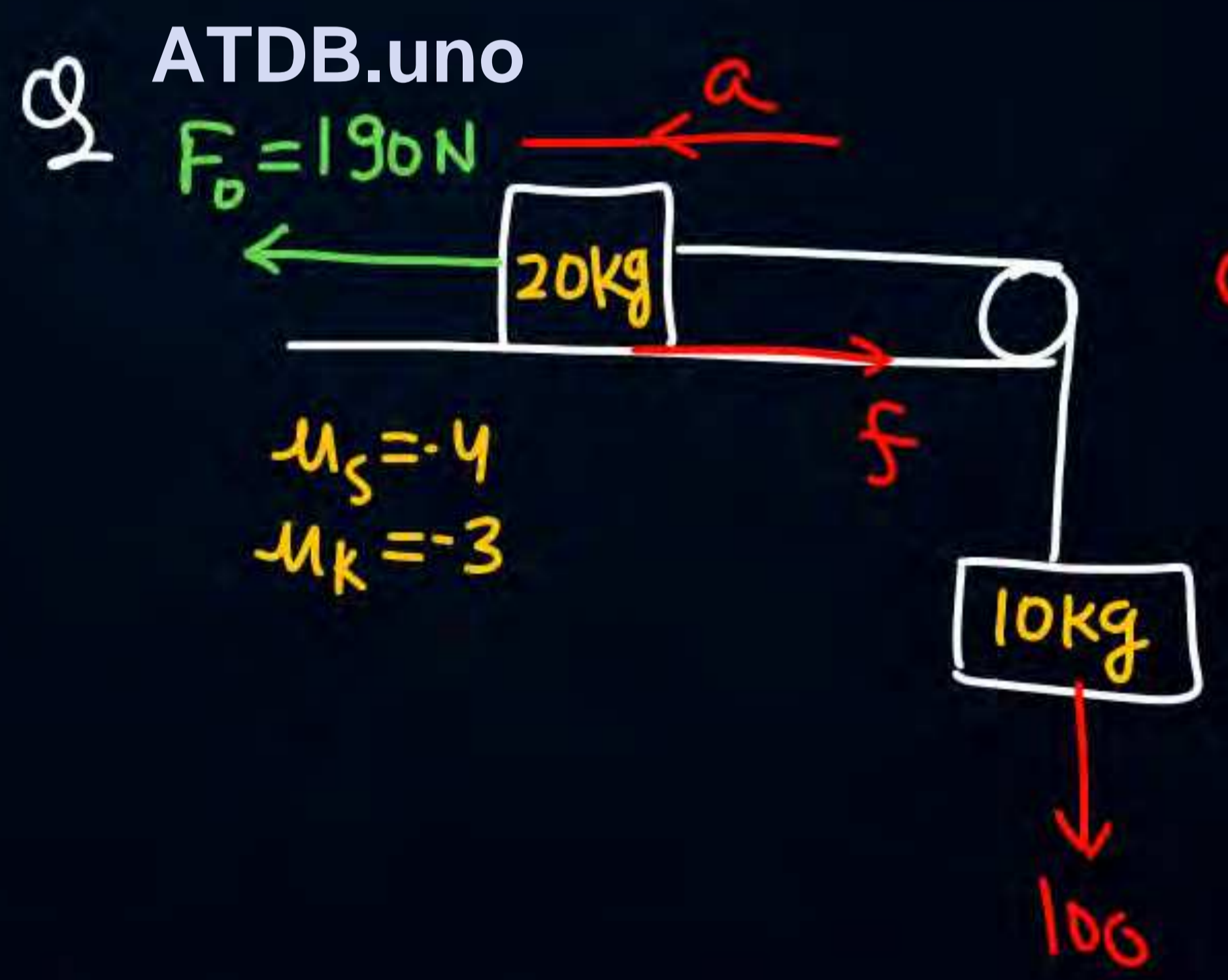
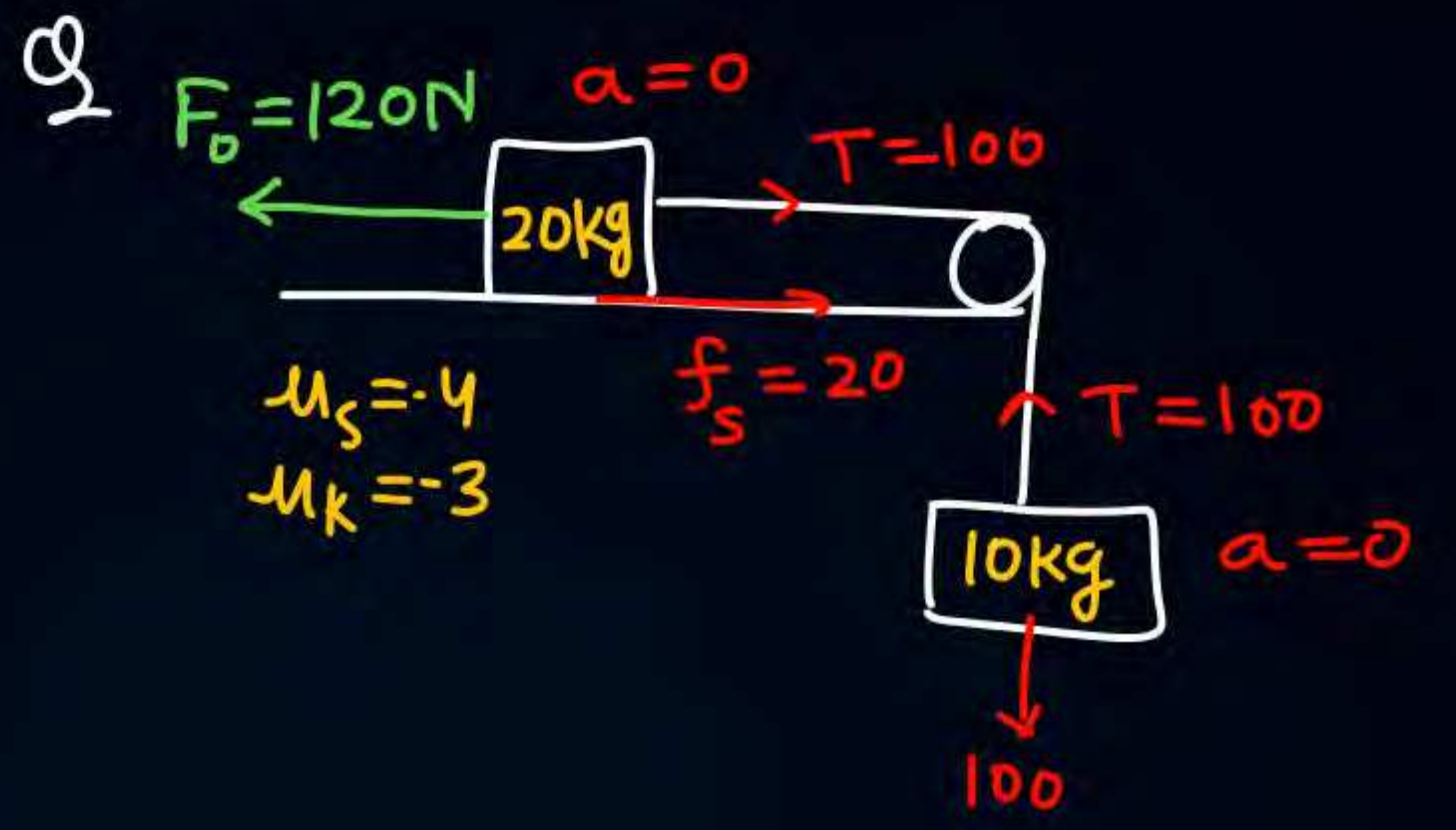

$$a = \frac{190 - 100 - 60}{30}$$

$a = 1$

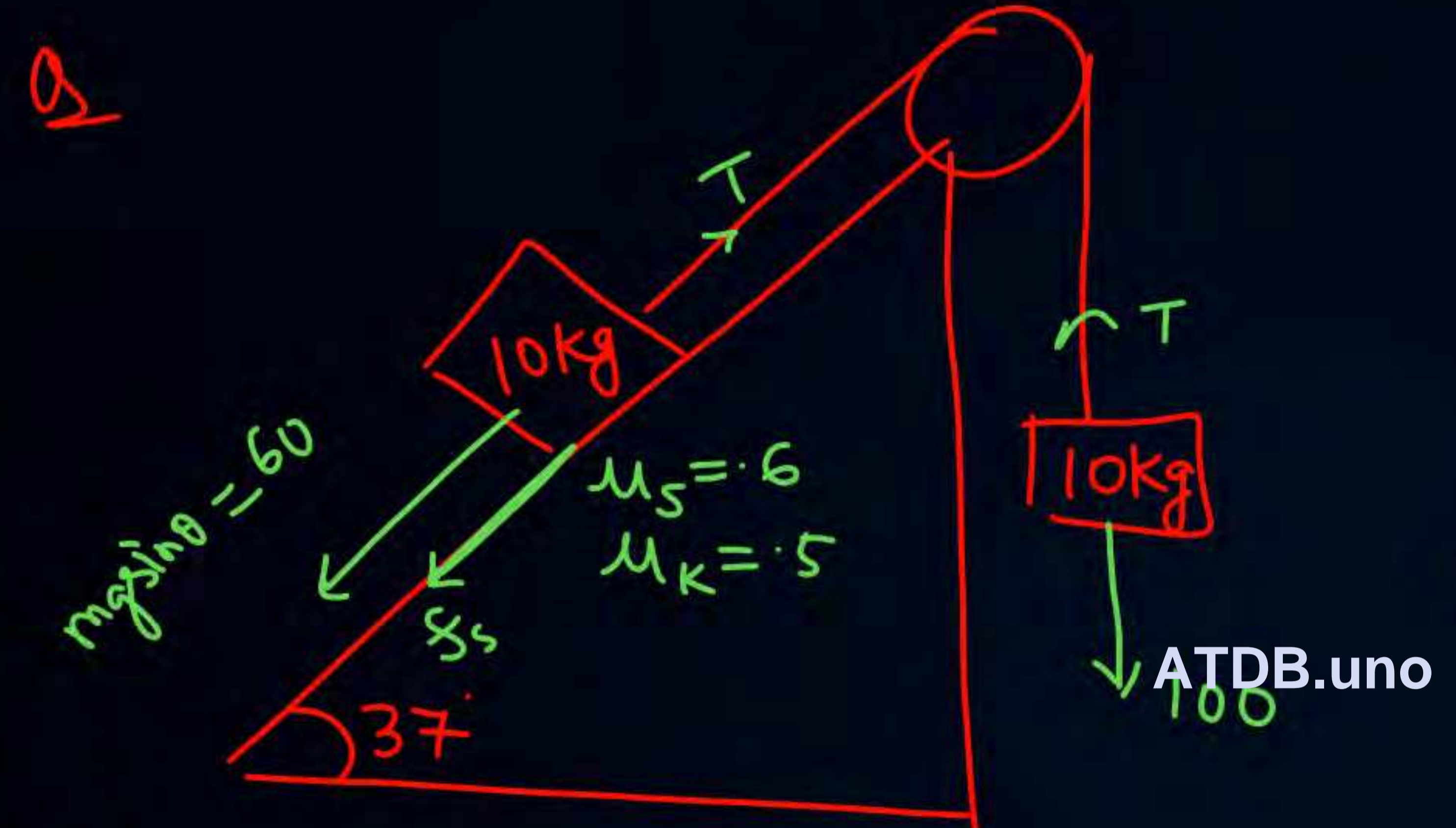

$(f_s)_{\max} = 0.6 \times mg \cos \theta = 0.6 \times 80 = 48$
 $a = 0, T = 100, f_s = 40$

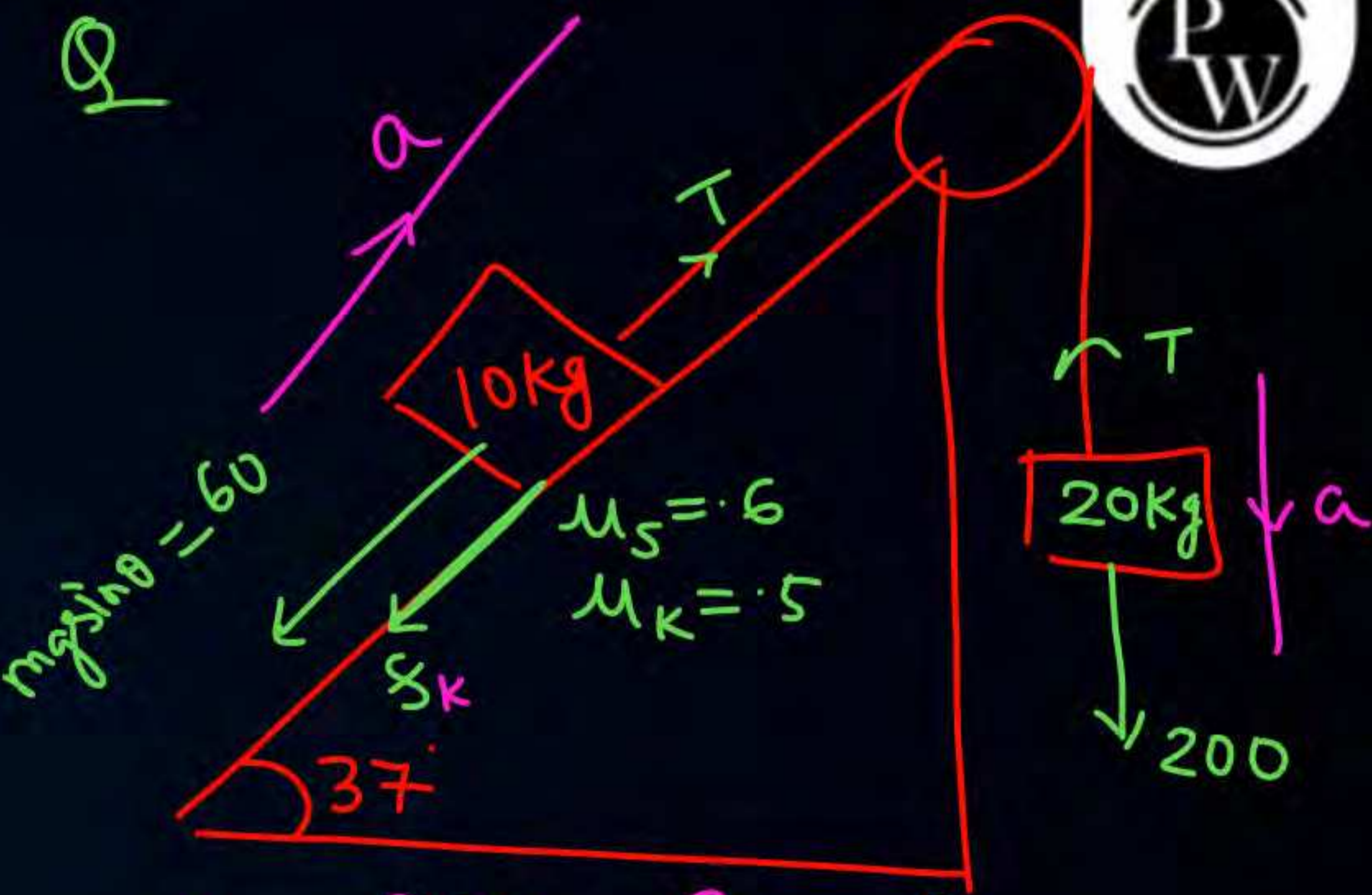

$a = \frac{200 - 60 - f_k}{30} = \frac{10}{3}$

$f_k = 0.5 \times 80 = 40$



Q

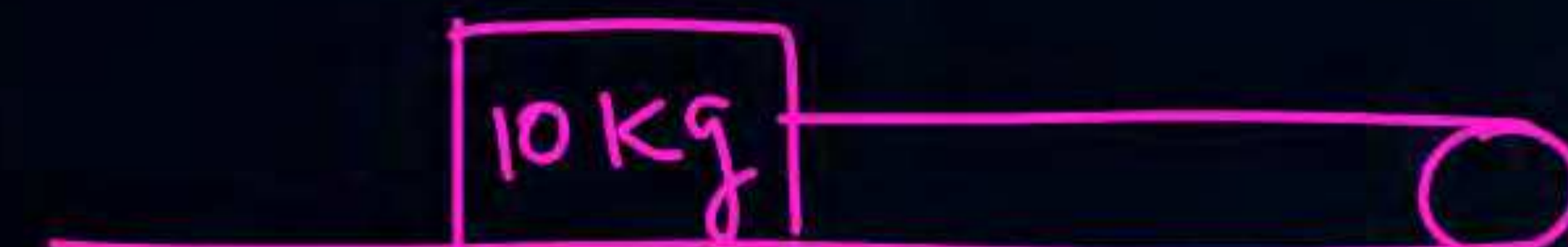

$$\mu = 0.6$$

|||

इसका मतलब है

$$\mu_s = 0.6$$

$$\mu_k = 0.6$$

$$10 \text{ kg} \downarrow a = \frac{100 - 60}{20} = 2$$



m-2

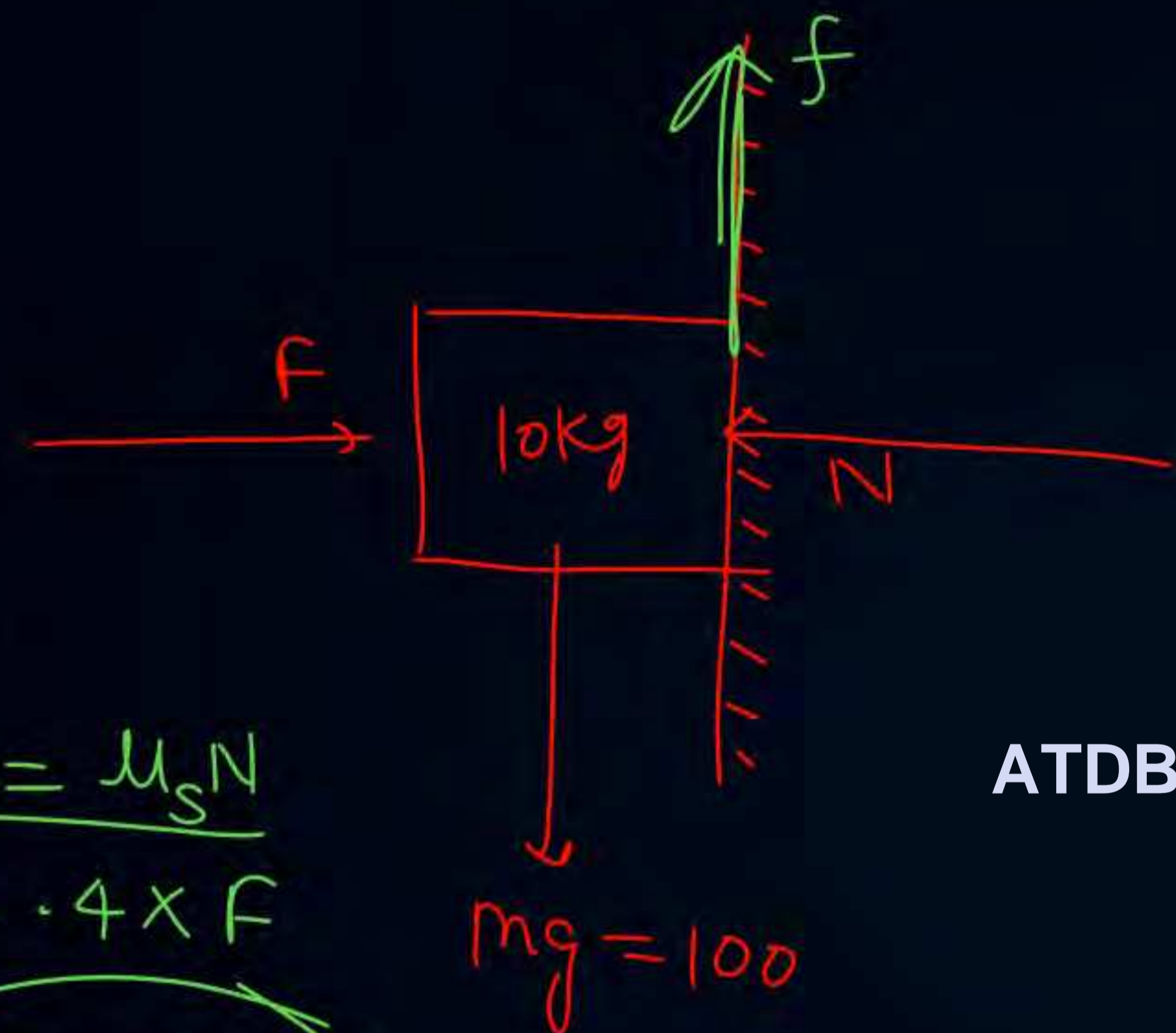

ATDB.uno

$$F = N$$

$$\underline{\max f = 100 = \mu_s N}$$

$$100 = .4 \times F$$

$$F = 250 \text{ N}$$



Kattar Advance Session Ques

ATDB.uno
Discussion Video will upload at evening

Paragraph for Questions no. 11 to 13

An insect I crosses a cylinder of radius R with minimum jumping speed. Path of the insect is shown in figure. When insect will be just touching the cylinder at C & D its velocity will be tangent to the cylinder at that point. At point C radius of the cylinder is making an angle α from the vertical. Minimum velocity

of insect is u, at an angle θ from the horizontal [Given : $R = \frac{2(\sqrt{2}-1)}{10}$ m & $g = 10$ m/s²]

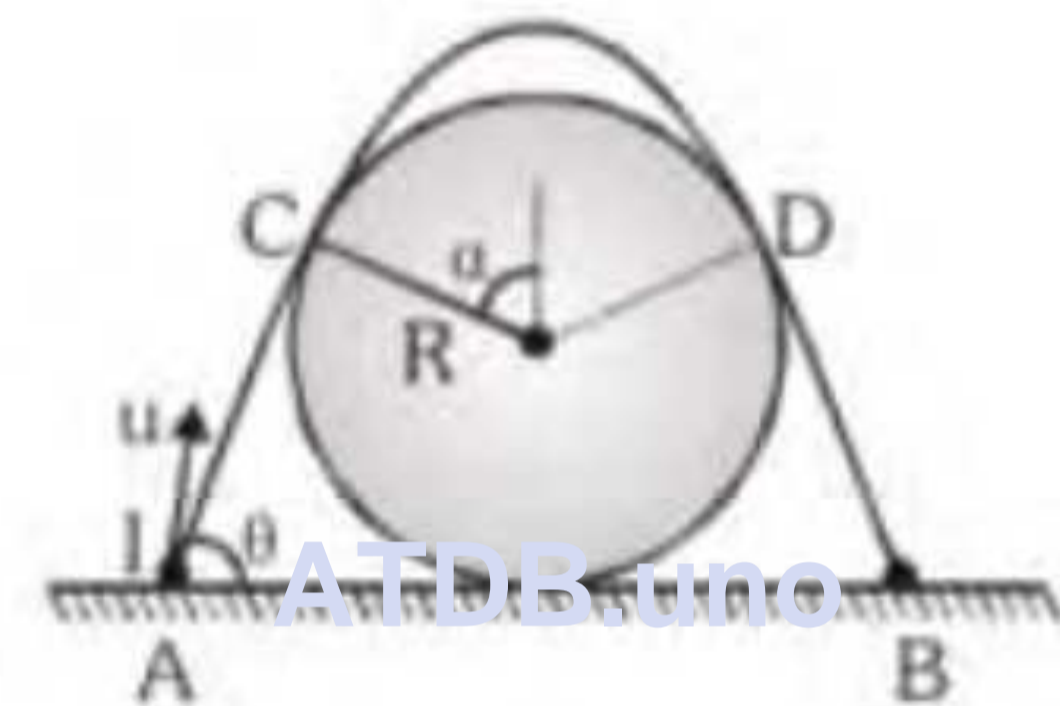

11. Value of α is

(A) $\sin^{-1} \frac{1}{(2)^{1/4}}$

(B) $\cos^{-1} \frac{1}{\sqrt{3}}$

(C) 45°

(D) 30°

12. Value of minimum velocity u in m/s is

(A) $\sqrt{2(2-\sqrt{2})}$

(B) $\sqrt{2\sqrt{2}}$

(C) 2

(D) 4

13. Value of θ is

(A) $\sin^{-1} \frac{1}{(2)^{1/4}}$

(B) $\cos^{-1} \sqrt{\frac{\sqrt{2}-1}{2\sqrt{2}}}$

(C) 45°

(D) 30°

24. A radius vector of a point A relative to the origin varies with time t as $\mathbf{r} = at\mathbf{i} - bt^2\mathbf{j}$, where a and b are positive constants, and \mathbf{i} and \mathbf{j} are the unit vectors of the x and y axes. Find :
- (a) the equation of the point's trajectory $y(x)$; plot this function;
 - (b) the time dependence of the velocity \mathbf{v} and acceleration \mathbf{w} vectors, as well as of the moduli of these quantities;
 - (c) the time dependence of the angle α between the vectors \mathbf{w} and \mathbf{v} ;
 - (d) the mean velocity vector averaged over the first t seconds of motion, and the modulus of this vector.

ATDB.uno





34. A balloon starts rising from the surface of the Earth. The ascension rate is constant and equal to v_0 . Due to the wind the balloon gathers the horizontal velocity component $v_x = ay$, where a is a constant and y is the height of ascent. Find how the following quantities depend on the height of ascent;

- (a) the horizontal, drift of the balloon $x(y)$;
- (b) the total, tangential, and normal accelerations of the balloon.

ATDB.uno

35. A particle moves in the plane xy with velocity $\mathbf{v} = a\mathbf{i} + bx\mathbf{j}$, where \mathbf{i} and \mathbf{j} are the unit vectors of the x and y axes, and a and b are constants. At the initial moment of time the particle was located at the point $x = y = 0$. Find :
- the equation of the particle's trajectory $y(x)$;
 - the curvature radius of trajectory as a function of x .



ATDB.uno

16. A tank is initially at a perpendicular distance $BT = 360$ m from the plane of firing as shown. The enemy tank is moving with a speed of 9 m/s in direction TA as shown in figure. A gun can fire shell in y - z plane only with a speed 100 m/s at an angle of 53° such that the shell lands at points A . If tank started at $t=0$ then time interval (in sec) after which shell is to be fired to hit the tank is

प्रदर्शित चित्र में एक टैंक प्रारम्भ में गोली दागने के प्रक्षेपण तल से $BT = 360$ m की लम्बवत् दूरी पर है। एक शत्रु का टैंक TA दिशा में 9 m/s की चाल से गतिशील है। एक बन्दूक y - z तल में लगी हुई है। यह 53° कोण पर 100 m/s की चाल से इस प्रकार गोली दागती है कि गोली केवल बिन्दु A पर ही टकराती है। यदि टैंक $t = 0$ समय पर गति करना प्रारम्भ कर दे तो वह समयान्तराल (सेकण्ड में) क्या होना चाहिये ताकि जिसके पश्चात् गोली दागने पर यह गोली टैंक से जा टकराये ?

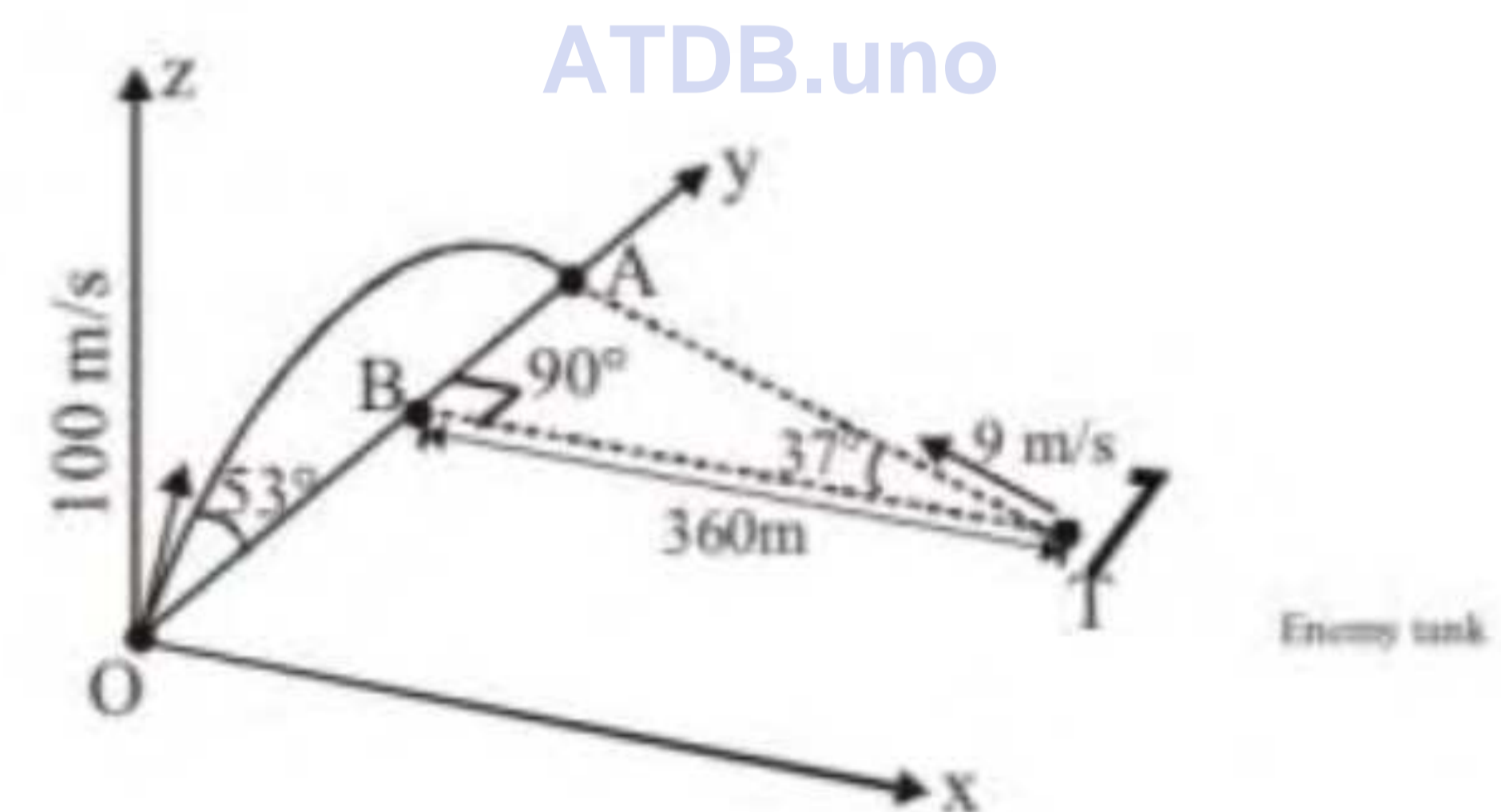

A small squirrel jumps from pole 1 to pole 2 in horizontal direction. Squirrel is observed by a very small observer at origin. What is average velocity vector of squirrel ? If average velocity vector is expressed as $v_x \hat{i} + v_y \hat{j} + v_z \hat{k}$, express your answer as sum of magnitudes of its components $|v_x| + |v_y| + |v_z|$ in unit m/s.

एक छोटी गिलहरी खम्भे 1 से खम्भे 2 तक क्षैतिज दिशा में कूदती है। इस गिलहरी को मूल बिन्दु पर खड़ा एक बहुत छोटा प्रेक्षक देखता है। गिलहरी का औसत वेग सदिश क्या होगा ? यदि औसत वेग सदिश को $v_x \hat{i} + v_y \hat{j} + v_z \hat{k}$ द्वारा दर्शाया जाए तो अपना उत्तर इसके घटकों के परिमाणों के योग $|v_x| + |v_y| + |v_z|$ के रूप में m/s में ज्ञात कीजिए।

ATDB.uno

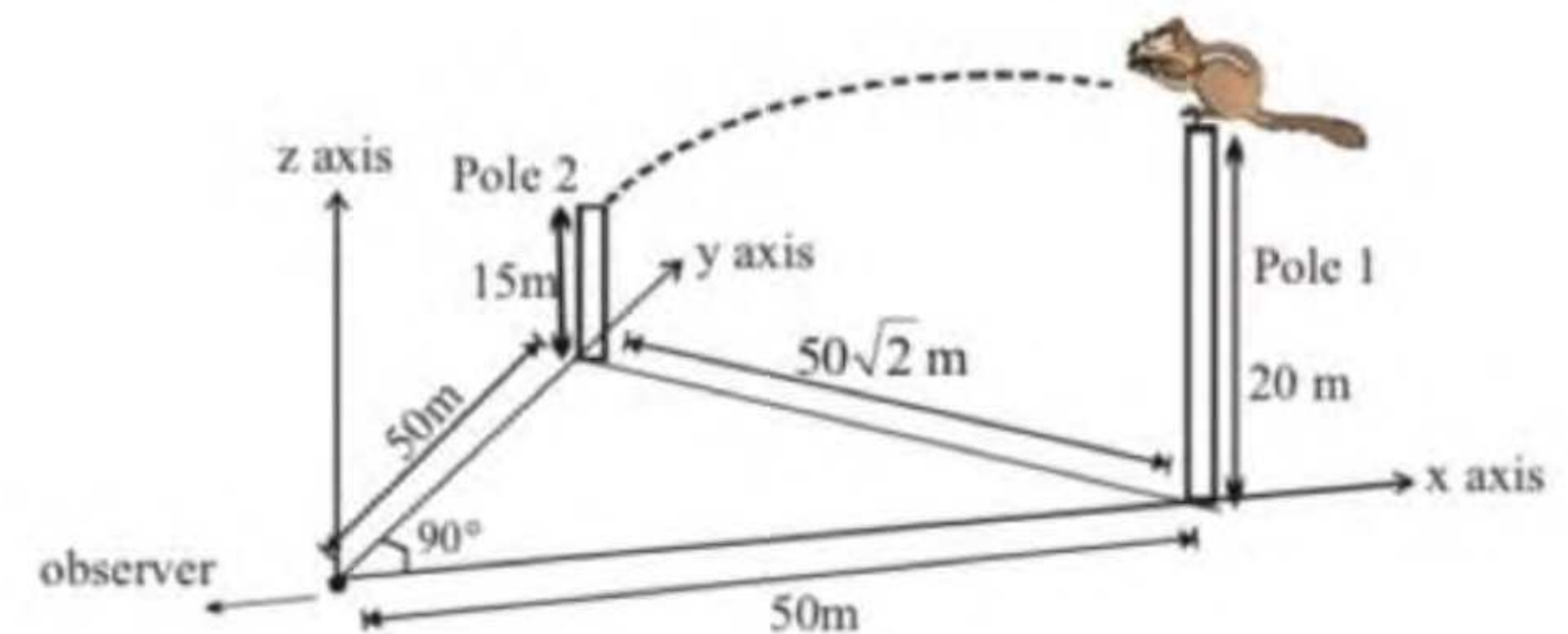

2. A box of dimension $10\text{ m} \times 6\text{ m} \times 8\text{ m}$ is kept on a frictionless inclined plane as shown in the figure. A stone is thrown from one corner P with speed 10 m/s parallel to the ceiling of the box such that it hits the floor of the box at point Q as shown. At the same instant, the box is released to slide down the plane. Calculate the time of flight in second. [$g = 10\text{ m/s}^2$]

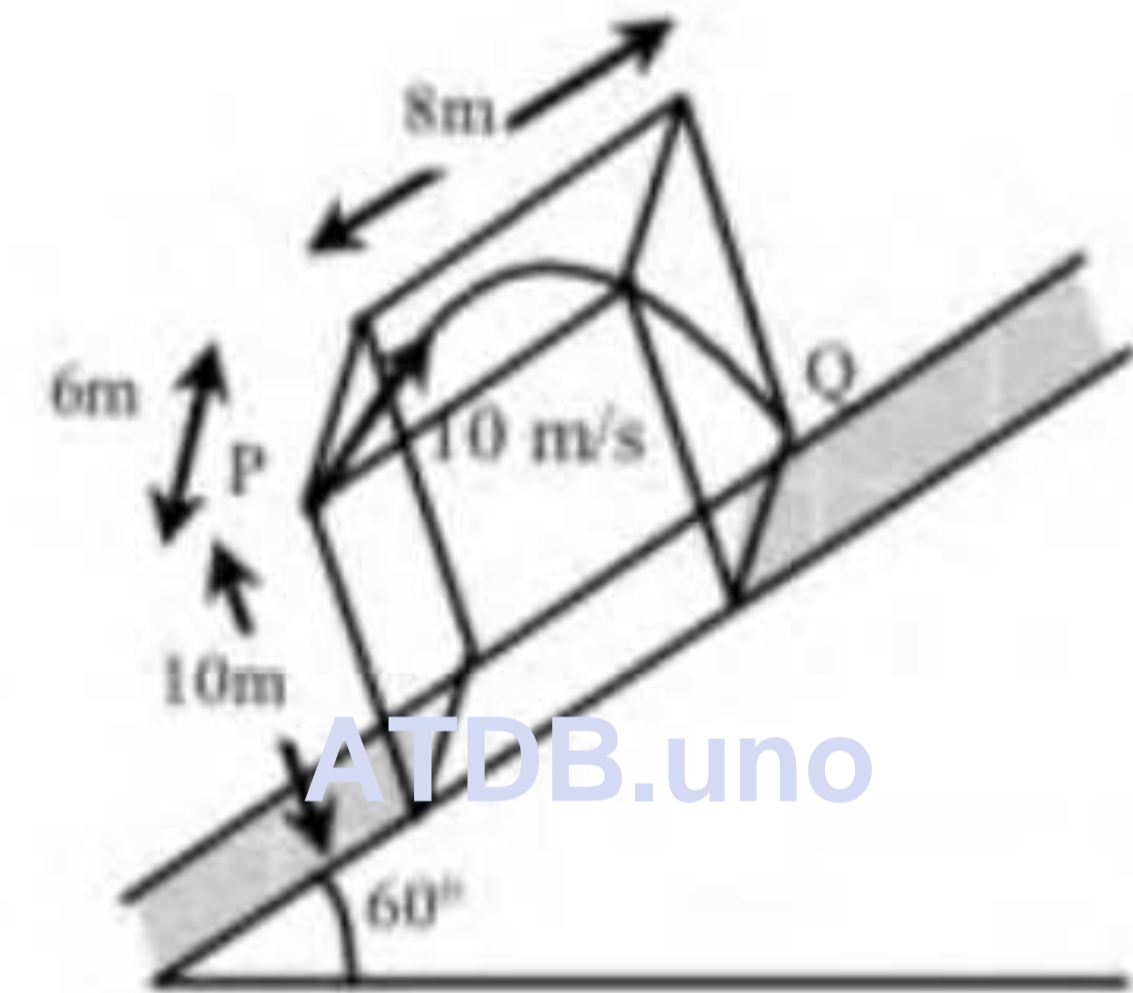

5. An accelerometer record for the motion of the given part of mechanism is approximated by an arc of a parabola for 0.2 sec and an straight line for next 0.2 sec as shown the diagram. Given that $v = 0$ when $t = 0$ and $x = 0.8$ m when $t = 0.4$ sec.

(A) Acceleration of particle at $t = 0.3$ sec is 8 m/s^2 .

(B) Velocity of particle at $t = 0.1$ sec is $\left(\frac{7}{3}\right) \text{ m/s}$.

(C) Velocity of particle at $t = 0.3$ sec is 6 m/s .

(D) Position of particle at $t = 0.2$ sec is 0.9 m

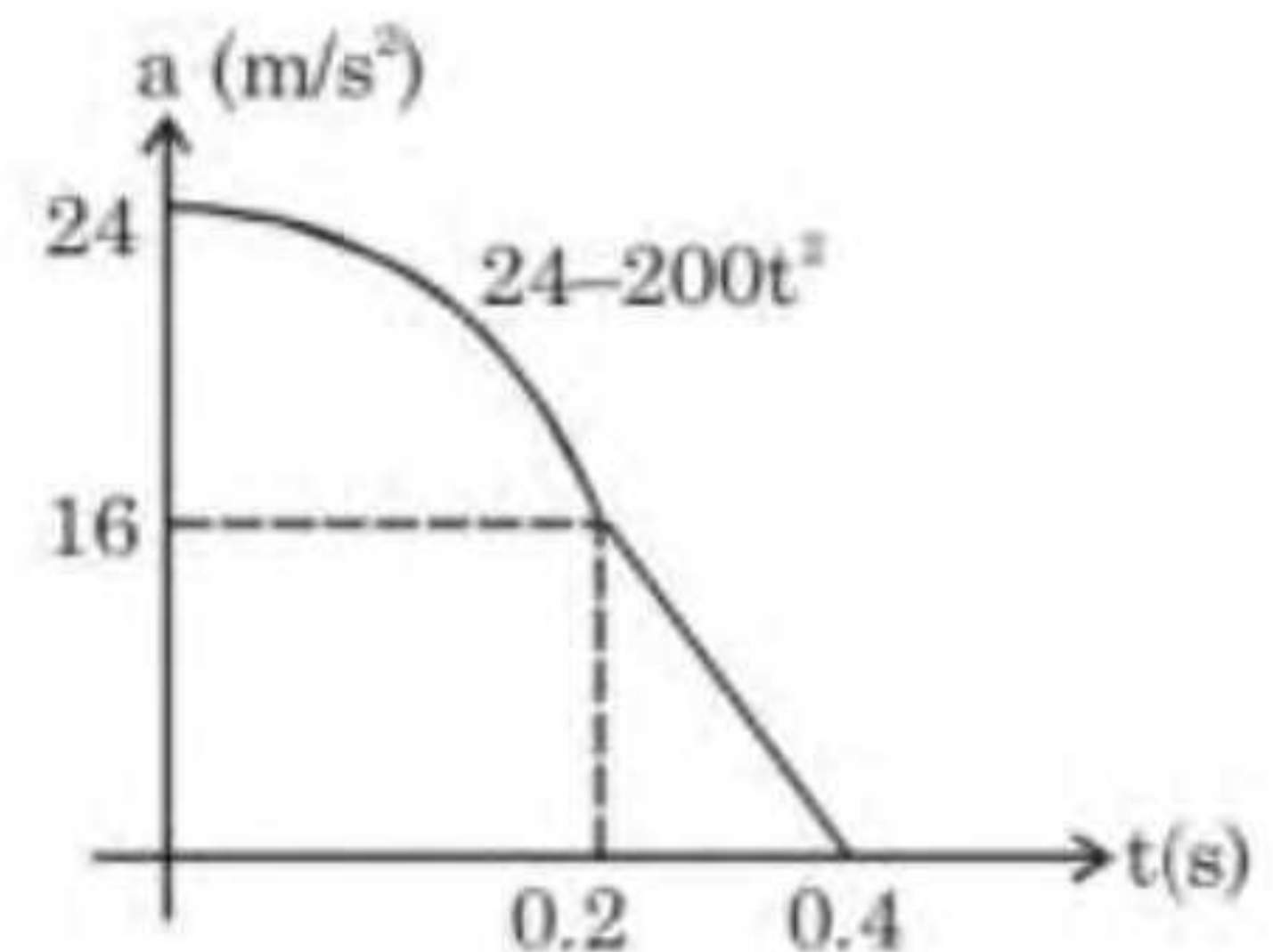

ATDB.uno

25. A train is moving along a straight line with a constant acceleration a . A boy standing in the train throws a ball forward with a speed of 10 m/s, at an angle of 60° to the horizontal. The boy has to move forward by 1.15 m inside the train to catch the ball back at the initial height. The acceleration of the train, in m/s^2 , is

[IIT-JEE 2011]

एक ट्रेन नियत त्वरण 'a' से एक सीधी रेखा पर चल रही है। ट्रेन में खड़ा एक लड़का 10 m/s के चाल से क्षैतिज से 60° के कोण पर एक गेंद आगे की ओर फेंकता है। लड़का ट्रेन में 1.15 m आगे चलकर गेंद को उसकी आरंभिक ऊंचाई पर पकड़ता है। ट्रेन के त्वरण का मान m/s^2 में है।

ATDB.uno

1. A rocket is moving in a gravity free space with a constant acceleration of 2 ms^{-2} along $+x$ direction (see figure). The length of a chamber inside the rocket is 4m . A ball is thrown from the left end of the chamber in $+x$ direction with a speed of 0.3 ms^{-1} relative to the rocket. At the same time, another ball is thrown in $-x$ direction with a speed of 0.2 ms^{-1} from its right end relative to the rocket. The time in seconds when the two balls hit each other is **[JEE Advanced 2014]**

एक रॉकेट गुरुत्वहीन अंतरिक्ष में नियत त्वरण 2 ms^{-2} से $+x$ दिशा में गतिमान है (चित्र देखिए)। रॉकेट के अन्दर कक्ष की लम्बाई 4m है। कक्ष की बाईं दीवार से एक गेंद रॉकेट के सापेक्ष 0.3 ms^{-1} की गति से $+x$ दिशा के अनुदिश फेंकी जाती है। ठीक उसी समय, एक दूसरी गेंद कक्ष की दाईं दीवार से रॉकेट के सापेक्ष 0.2 ms^{-1} की गति से $-x$ दिशा के अनुदिश फेंकी जाती है। दोनों गेंदों के एक दूसरे से टकराने तक लगने वाला समय सेकण्ड में है :

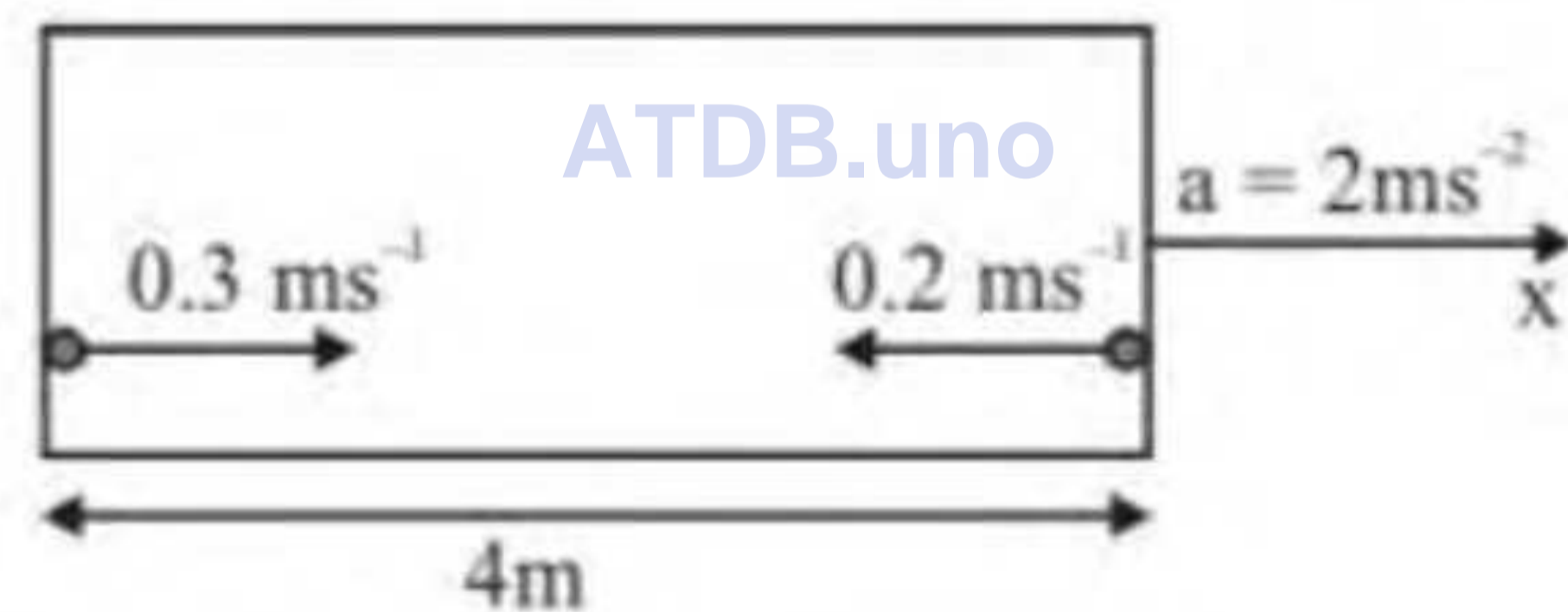

2. Airplanes A and B are flying with constant velocity in the same vertical plane at angles 30° and 60° with respect to the horizontal respectively as shown in figure. The speed of A is $100\sqrt{3} \text{ ms}^{-1}$. At time $t = 0 \text{ s}$, an observer in A finds B at a distance of 500 m. This observer sees B moving with a constant velocity perpendicular to the line of motion of A. If at $t = t_0$, A just escapes being hit by B, t_0 in seconds is

[JEE Advanced-2014]

विमान A तथा विमान B नियत वेग के सापेक्ष क्षैतिज के सापेक्ष क्रमशः 30° तथा 60° का कोण बनाते हुए एक ही ऊर्ध्व तल में उड़ान भर रहे हैं। जैसा चित्र में दर्शाया गया है। विमान A की गति $100\sqrt{3} \text{ ms}^{-1}$ है। समय $t = 0 \text{ s}$ पर विमान A में एक प्रेक्षक के अनुसार B उससे 500 m की दूरी पर है। प्रेक्षक के अनुसार विमान B एक नियत वेग से A की गति की दिशा के लम्बवत दिशा में गतिमान है। यदि समय $t = t_0$ पर विमान A विमान B से टकराने से बाल-बाल बचता है, तब समय t_0 का सेकण्ड में मान है :

ATDB.uno

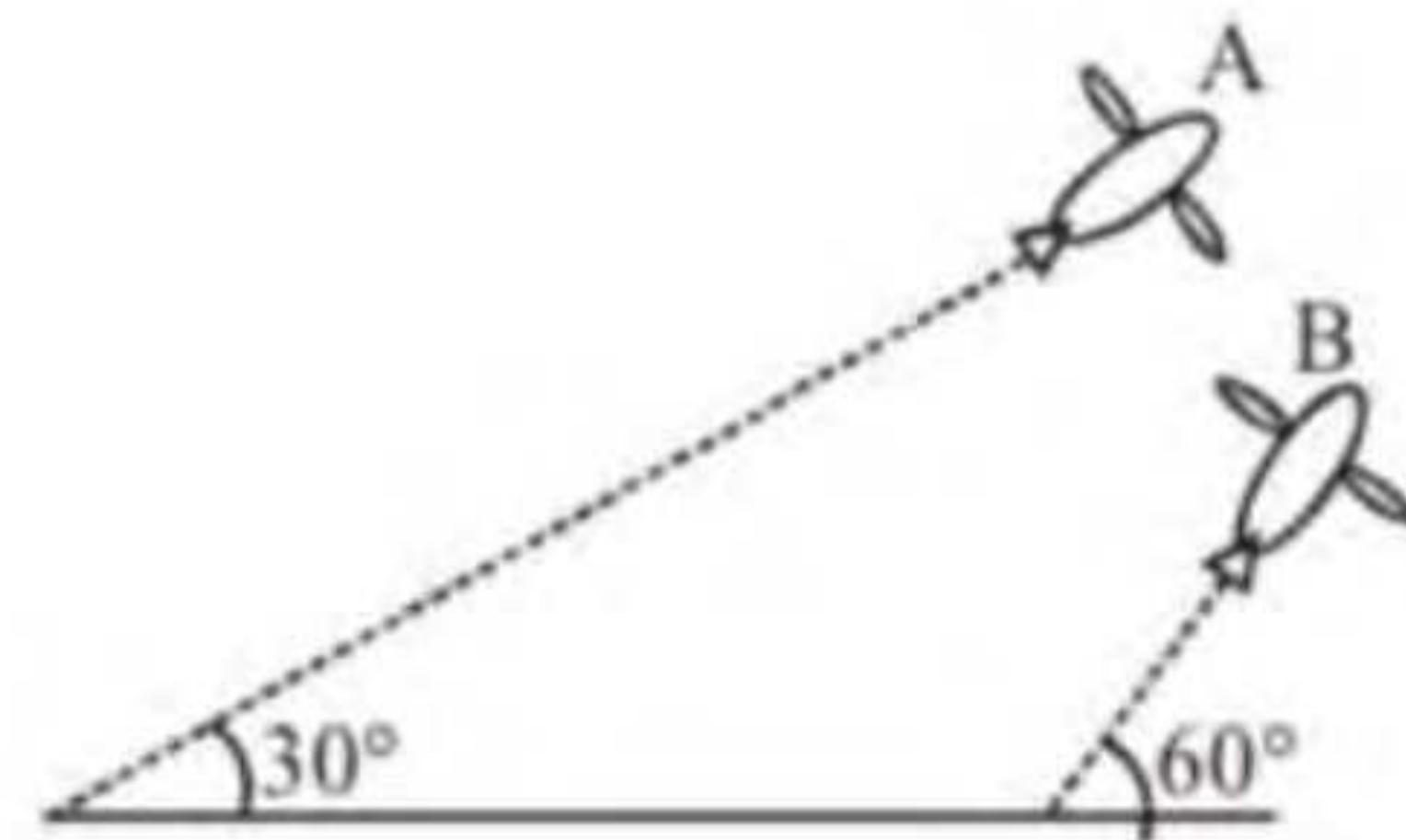

A projectile is fired from horizontal ground with speed v and projection angle θ . When the acceleration due to gravity is g , the range of the projectile is d . If at the highest point in its trajectory, the projectile enters a different region where the effective acceleration due to gravity is $g' = \frac{g}{0.81}$, then the new

range is $d' = nd$. The value of n is _____.

[JEE Advanced-2022]

एक प्रक्षेपण को समतल धरातल से गति v तथा प्रक्षेप कोण θ से प्रक्षेपित किया गया है। जब गुरुत्वाकर्षण के कारण त्वरण g है तो प्रक्षेपण की परास d है। यदि अपने प्रक्षेप पथ की अधिकतम ऊँचाई पर, प्रक्षेप्य एक अन्य क्षेत्र में प्रवेश करता है

जिसका प्रभावी त्वरण $g' = \frac{g}{0.81}$ है तब नयी परास $d' = nd$ है। n का मान _____ है।

[JEE Advanced-2022]

ATDB.uno

1. A particle travels so that its acceleration is given by $\mathbf{a} = 5 \cos t \mathbf{i} - 3 \sin t \mathbf{j}$. If the particle is located at $(-3, 2)$ at time $t = 0$ and is moving with a velocity given by $(-3\hat{\mathbf{i}} + 2\hat{\mathbf{j}})$. Find
- the velocity at time t and
 - the position vector of the particle at time $(t > 0)$.

एक गतिशील कण का त्वरण $\vec{a} = 5 \cos t \hat{\mathbf{i}} - 3 \sin t \hat{\mathbf{j}}$ है। यदि $t = 0$ पर कण बिन्दु $(-3, 2)$ पर हो तथा यह वेग $(-3\hat{\mathbf{i}} + 2\hat{\mathbf{j}})$ से गतिशील हो तो ज्ञात कीजिये

- समय t पर वेग
- समय $(t > 0)$ पर कण का स्थिति सदिश

ATDB.uno

9. A large heavy box is sliding without friction down a smooth plane of inclination θ . From a point P on the bottom of the box, a particle is projected inside the box. The initial speed of the particle with respect to box is u and the direction of projection makes an angle α with the bottom as shown in figure. [JEE]

- (i) Find the distance along the bottom of the box between the point of projection P and the point Q where the particle lands. (Assume that the particle does not hit any other surface of the box. Neglect air resistance).
- (ii) If the horizontal displacement of the particle as seen by an observer on the ground is zero, find the speed of the box with respect to the ground at the instant when the particle was projected.

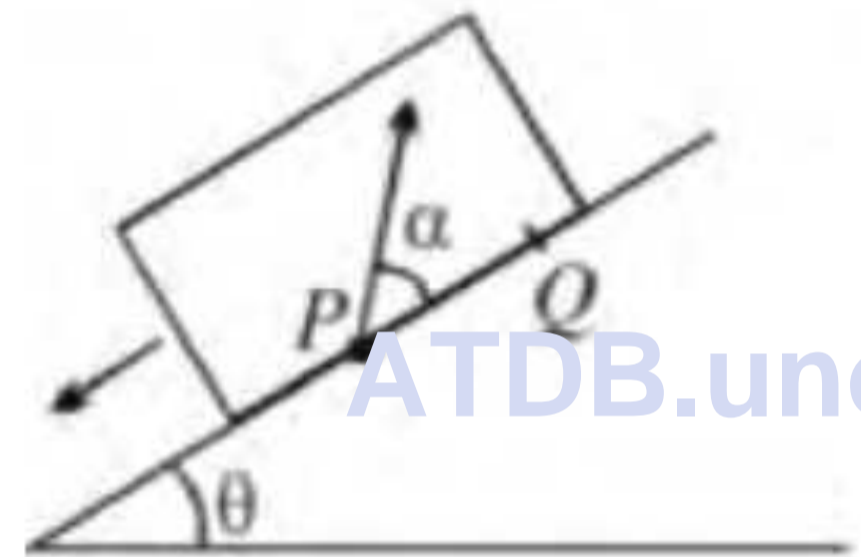

एक बड़ा भारी बक्सा θ झुकाव वाले घर्षणरहित नत-तल पर बिना घर्षण नीचे की ओर फिसल रहा है। बक्से के पैदे पर स्थित बिन्दु P से एक कण को बक्से के अन्दर प्रक्षेपित किया जाता है। बक्से के सापेक्ष कण की प्रारम्भिक चाल u है तथा प्रक्षेपण की दिशा पैदे के साथ चित्रानुसार α कोण बनाती है।

- (i) प्रक्षेपण बिन्दु P तथा बिन्दु Q (जहाँ कण गिरता है) के मध्य बक्से के पैदे के अनुदिश दूरी ज्ञात कीजिए।

(मान लीजिए कि कण बक्से की किसी अन्य सतह से नहीं टकराता है। वायु प्रतिरोध को नगण्य मानिये)

- (ii) यदि धरातल पर स्थित एक प्रेक्षक द्वारा प्रेक्षित कण का क्षैतिज विस्थापन शून्य है तो उस क्षण जब कण को प्रक्षेपित किया गया था, धरातल के सापेक्ष बक्से की चाल ज्ञात कीजिए।



23. A projectile is fired at an angle θ with the horizontal. Find the condition under which it lands perpendicular on an inclined plane inclination α as shown in figure.

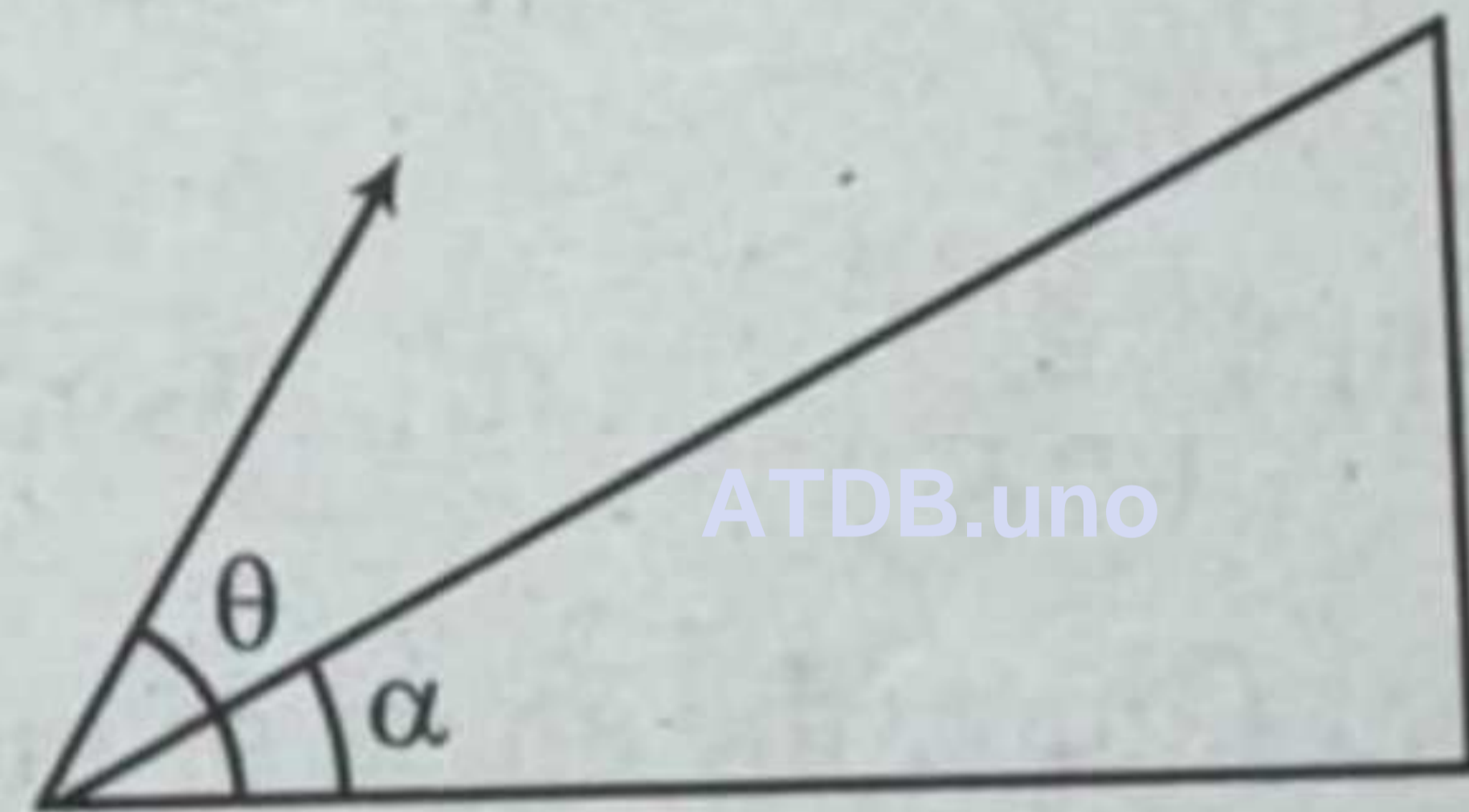

(a) $\sin \alpha = \cos (\theta - \alpha)$

(b) $\cos \alpha = \sin (\theta - \alpha)$

(c) $\tan \alpha = \cot (\theta - \alpha)$

(d) $\cot (\theta - \alpha) = 2 \tan \alpha$



6. The smooth wedge is accelerated at $\frac{g \cot \theta}{2}$ to the

right. A cubical box of side a is moving along with it. Inside the box a particle is projected with speed u relative to the box at an angle of 45° as shown. Find the time after which the particle will hit the box. [Assuming a is large, so that particle does not collide with top]

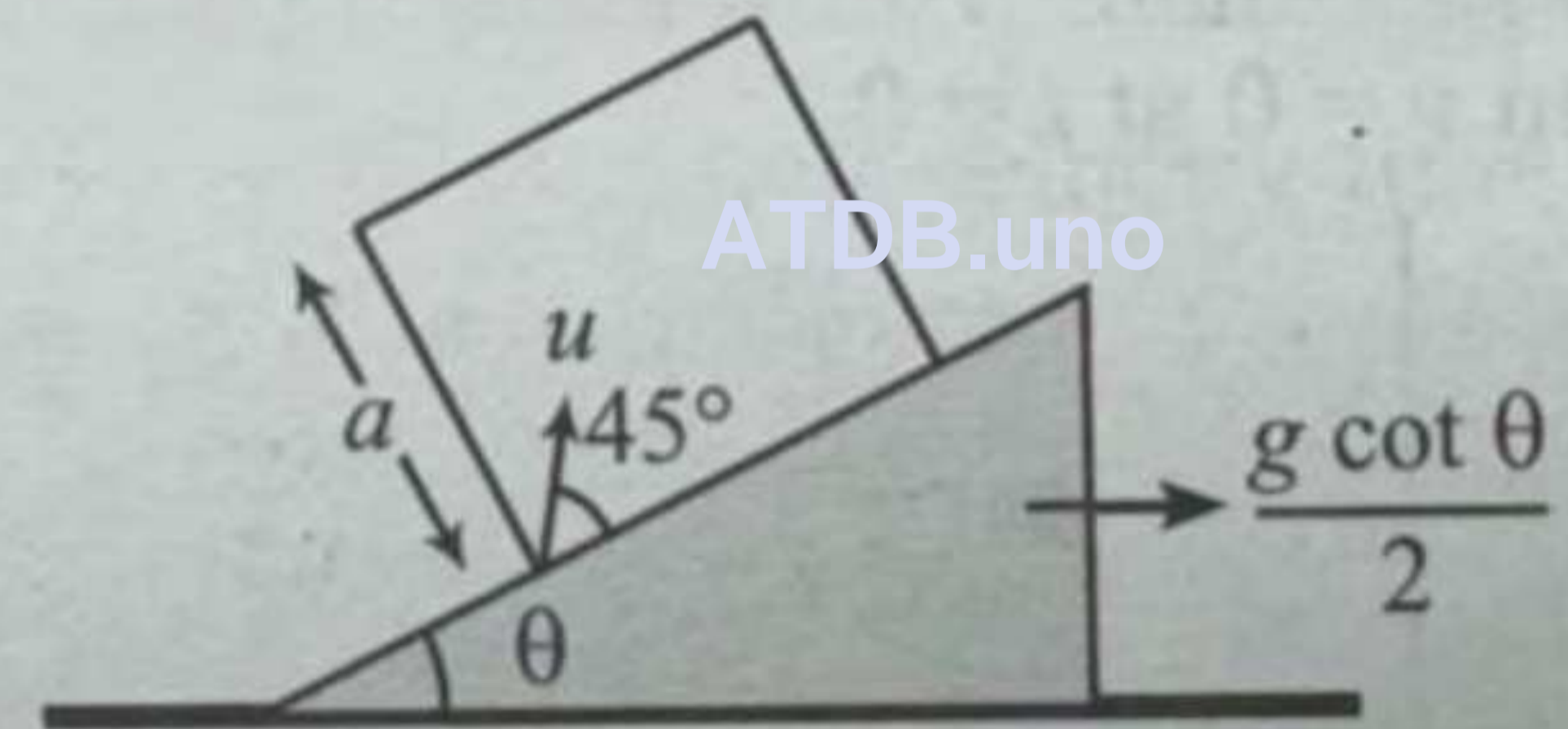

(a) $\frac{u}{\sqrt{2}g \sin \theta}$

(b) $\frac{2\sqrt{2}u}{g \cos \theta}$

(c) $\frac{u}{g \sin \theta}$

(d) $\frac{u}{\sqrt{2}g \cos \theta}$



83. A particle is projected at angle 60° with speed $10\sqrt{3} \text{ ms}^{-1}$, from the point 'A' as shown in the figure. At the same time the wedge is made to move with speed $10\sqrt{3} \text{ ms}^{-1}$ towards right as shown in the figure. Then the time after which particle will strike with wedge in second is

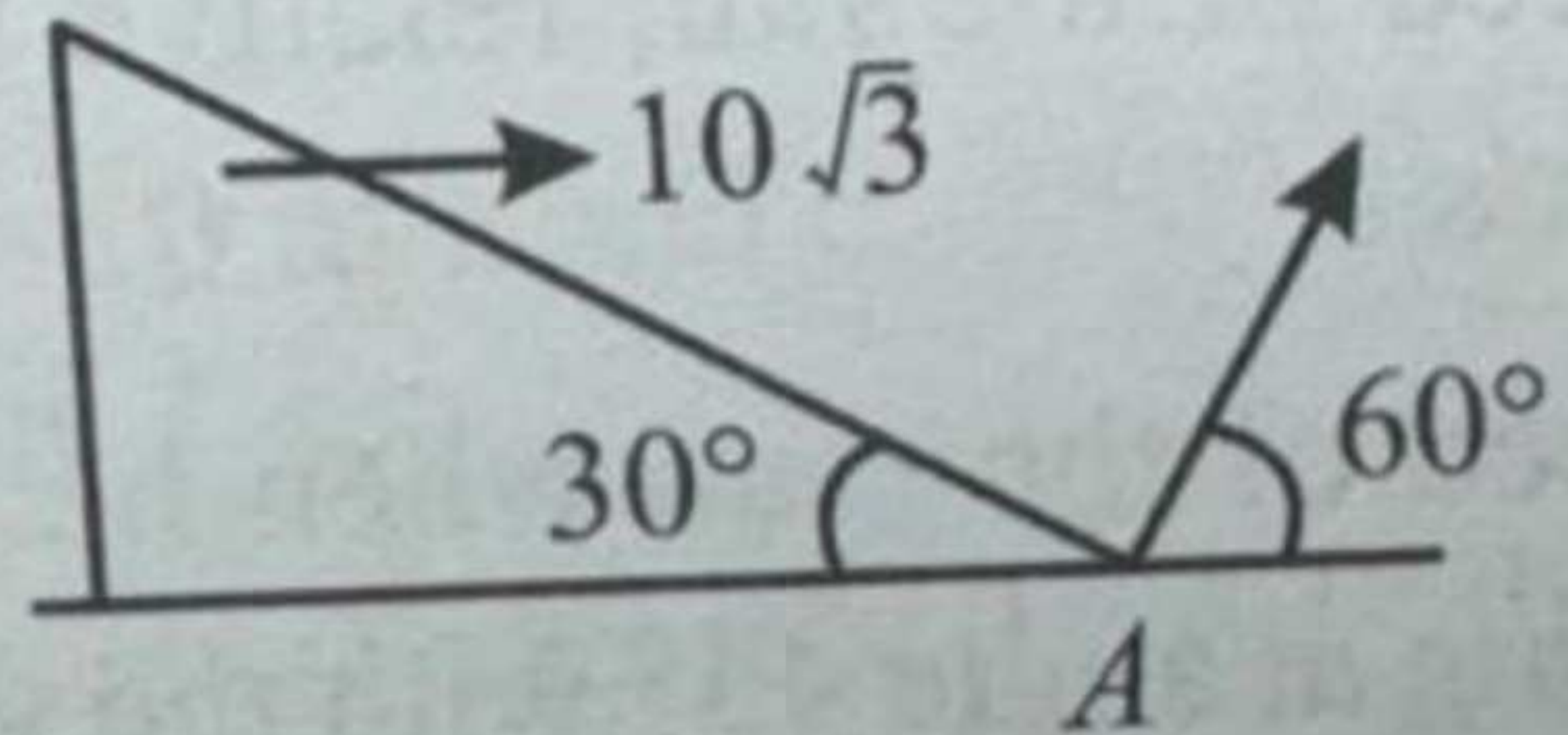

ar
le
a
ng

107. A particle is projected up an incline at $t = 0$ (inclination = 53°) with speed 14 m/s and at an angle 30° from the incline. At the same moment a box starts sliding down, the box has 2 small hole at height of 2m on opposite walls. The particle centers form 1st window and leave through the other. The width (in meter) of the box is $\frac{7K}{\sqrt{3}}$. Find the value of K .

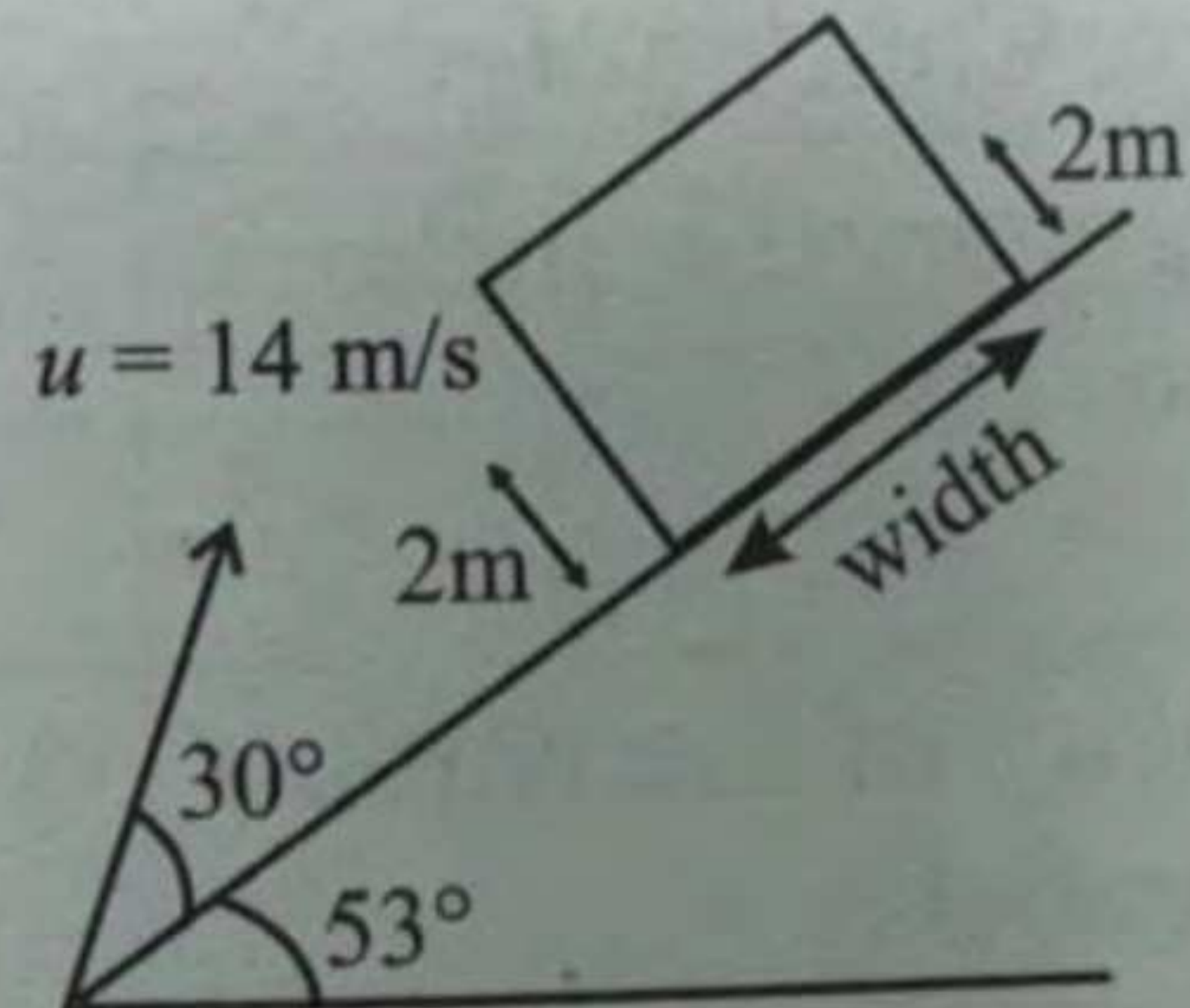

40. The diagram shows the vertical plane containing the path of a particle which is projected from a point O on an inclined plane (sufficiently long)

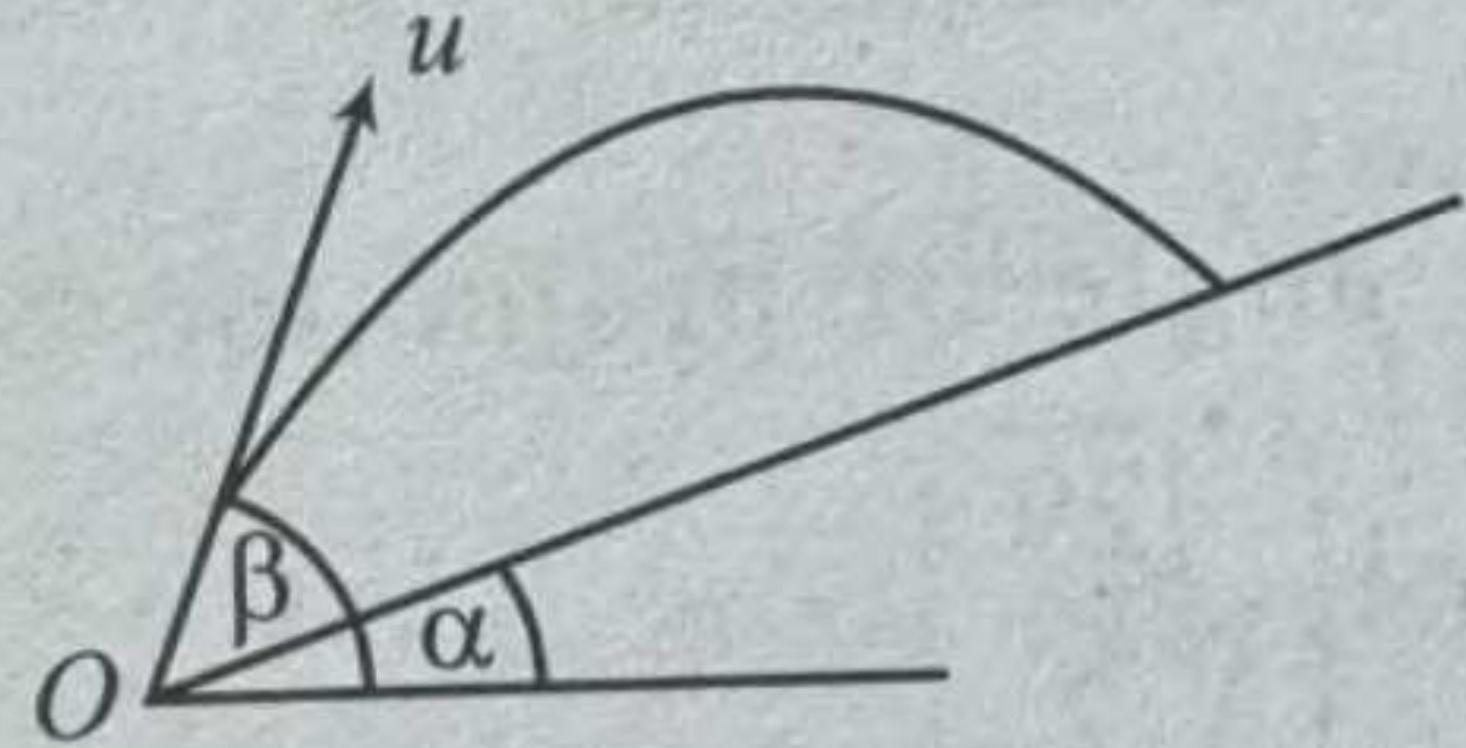

- (a) if the range on the plane is maximum then

$$\beta = \frac{\pi}{4} + \frac{\alpha}{2}$$

- (b) if T is the time of flight, the particle is at its greatest height above the plane after an interval $T/2$

- (c) the maximum range is $\frac{u^2}{2g} (\sec^2 \alpha - \tan \alpha \sec \alpha)$

- (d) the speed of the particle will be non-zero throughout the flight.





Home Work

— DPP-07 (must try)

— module H.W \equiv Monday \Rightarrow Prarambh \Rightarrow (12-27) (30-47),
 Tuesday \Rightarrow Prarambh \Rightarrow (48-61)

Wednesday = Prarambh \Rightarrow (75-82), Prabal (1-18)

Thursday \Rightarrow Prarambh \Rightarrow (62-73),

Friday \rightarrow Prabal (20-34), (42-48)

Saturday \Rightarrow JA \Rightarrow (1-18), 20, 35, 44, 45



THANK YOU

ATDB.uno

